



RFM Integrated Device, Inc.

PRODUCT SPECIFICATION

Part Number: ANT1035

Antenna, Ceramic Patch
(12×12×4.0mm)

GPS:1575.42 ±1.023 MHz

GLONASS:1602±5MHz

BW 11MHz min

Gain @ Zenith, dBi 0.0/1.0

1 SCOPE

This specification covers the dielectric Patch antenna for **GPS+GLONASS**.

2 Name of the product

This product is named "Dielectric Antenna".



3 Electrical characteristics

3-1 Electrical characteristics of antenna

The antenna has the electrical characteristics given in Table 1 under the manufacturer's standard installation conditions shown in the figure.

Table 1

No	Parameter	Specification	Notes
1	Range Of Receiving Frequency	GPS : 1575.42 ±1.023 MHz GLONASS : 1602±5MHz	
2	Center Frequency	1586MHz ± 3MHz	With 44.84x47.00mm GND Plane
3	Bandwidth	11MHz min	Return Loss@-10dB
4	VSWR	1.8 max	Center Frequency
5	Gain at Zenith	GPS : 0 dBi typ. GLONASS : 1.0 dBi typ.	
6	Gain at 10° Elevation	- - -	
7	Axial Ratio	- - -	
8	Impedance	50 Ohm	
9	Frequency Temperature Coefficient (f)	-40°C to +105°C	0 ± 20ppm / °C
10	Operating Temperature	-40°C to +105°C	

※ Please follow the Golden Sample characteristics and compensation the instrument measurement value when IQC Inspection.

4 Environmental conditions

4-1 Operating conditions

The antenna has the electrical characteristics given in Tables 1 in the temperature range of -40°C to +105°C and under the environmental conditions of +40°C and 0-95% r.h..

4-2 Storage temperature range

The storage temperature range of product is -40°C to +105°C.

4-3 Feed pin temperature range

Maximum temperature for soldering of feed pin is +290°C for 3 second.

5 Reliability tests

5-1 Low-temperature test

Expose the specimen to -40°C for 400 hours and then to normal temperature/humidity for 24 hours or more. After this test, examine its appearance and functions.

5-2 High-temperature test

Expose the specimen to +105°C for 400 hours and then to normal temperature/humidity for 24 hours or more. After this test, examine its appearance and functions.

5-3 High-temperature/high-humidity test

Subject the object to the environmental conditions of +60°C and 90-95% r.h. for 96 hours, then expose to normal temperature/humidity for 24 hours or more. After this test, examine its appearance and functions.

5-4 Thermal shock test

Subject the object to cyclic temperature change (-40°C, 2 hours \leftrightarrow +85°C, 2 hours) for 100 cycles, then expose to normal temperature/humidity for 24 hours or more.

5-5 Vibration test

5-5-1 Sinusoidal vibration test

Subject the object to vibrations of 5 to 200 to 5Hz swept in 10 minutes, 4.5G at maximum (2mm amplitude), in X and Y directions for two hours each and in Z direction for four hours. After this test, examine its appearance functions.

5-5-2 Vibration test in packaged condition

Subject the object, which is packaged as illustrated, to vibrations of 15 to 60 to 15Hz swept in 6 minutes, 4G at maximum (2mm amplitude at maximum), applied in X, Y and Z directions for two hours each, i.e. six hours in total. After this test, examine its appearance and functions.

5-6 Free fall test in packaged condition

Drop the object, which is packaged as illustrated, to a concrete surface from the height of 90 cm, on one corner, three edges and six faces once each, i.e. 10 times in total. After this test, examine its appearance and functions.

5-7 Soldering heat resistance test

The lead pins of the unit are soaked in solder bath at $260 \pm 5^\circ\text{C}$ for 10 seconds. After this test, examine its appearance and functions.

5-8 Adhesion test

The device is subjected to be soldered on test PCB. Then apply 0.5Kg (5N) of force for 5 ± 1 seconds in the direction parallel to the substrate. (The soldering should be done by reflow and be conducted with care so that the soldering is uniform and free of defect by stress such as heat shock).

6 Inspection

As for the examination during mass production, we place the antenna in the production fixture individually, using the network analyzer to compare its central frequency, bandwidth, and return loss with that of the golden sample.

7 Test Record

A Copy of test record filled with following contents shall be provided at time of delivery.

7-1 Quantity of delivery

7-2 Measurement of electrical characteristics

Following data at normal temperature obtained by the method described in section 17.

7-3 Temperature and humidity of test

Quantity for sampling inspection shall be $n=5$ for any lot. In case quantity per lot is less than 5, the whole lot shall be inspected.

8 Warranty

If any defect occurs from the product during proper use within a year after delivery, it will be repaired or replaced free of charge.

9 Others

Any question arising from this specification manual shall be solved by arrangement made by both parties.

10 Precautions for Use

- Antenna pattern use a silver electrode.
- Please don't use the corrosion gas (sulfur gas, chlorine gas) in the atmosphere.
- Please don't direct solder onto the silver electrode of Antenna pattern.

11 Shape and Dimension

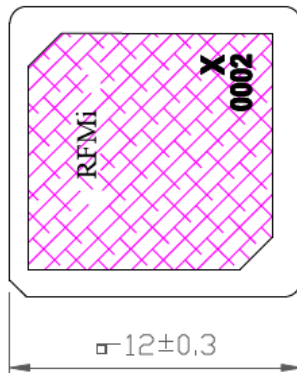

12 Typical Electrical Characteristics (T=25°C)

Return Loss, SWR, Impedance, measured on the test fixture.

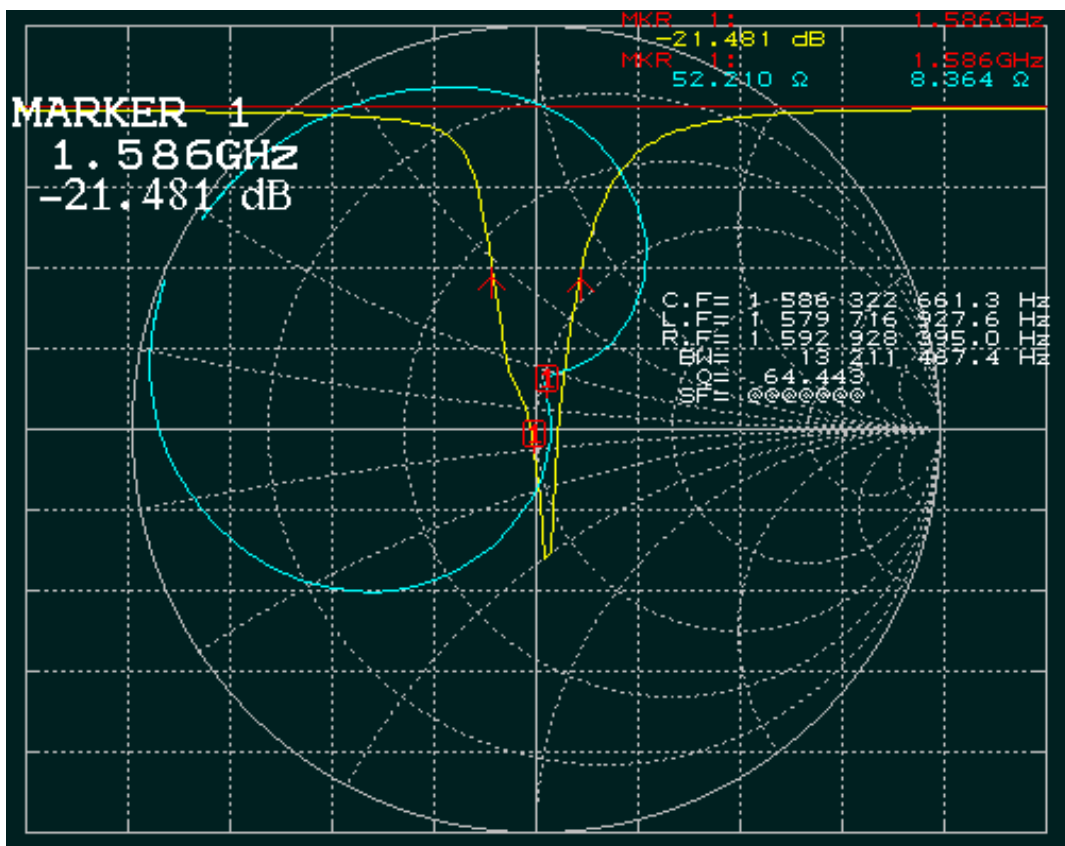

13 Mark

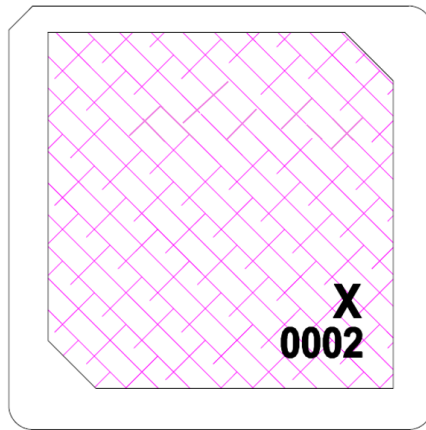

NOTE:
X: manufacture location

14 Test Fixture Dimension

Corner radius R=0.5

15 Test Fixture Antenna Setup & Measurements

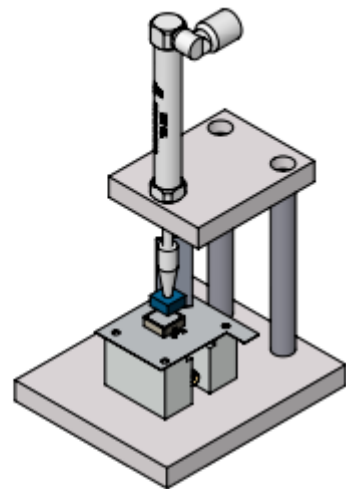
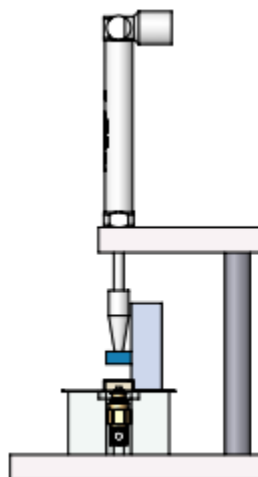
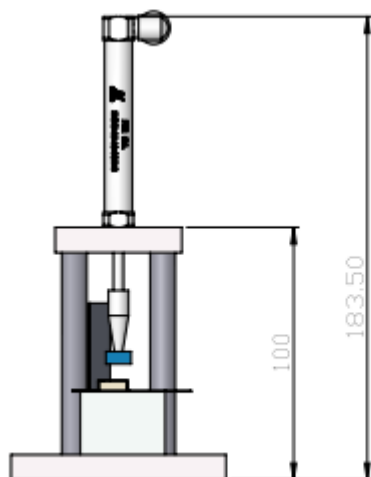
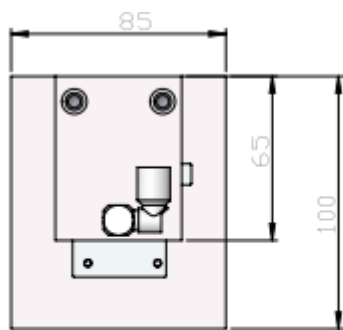

16 Delivery mode

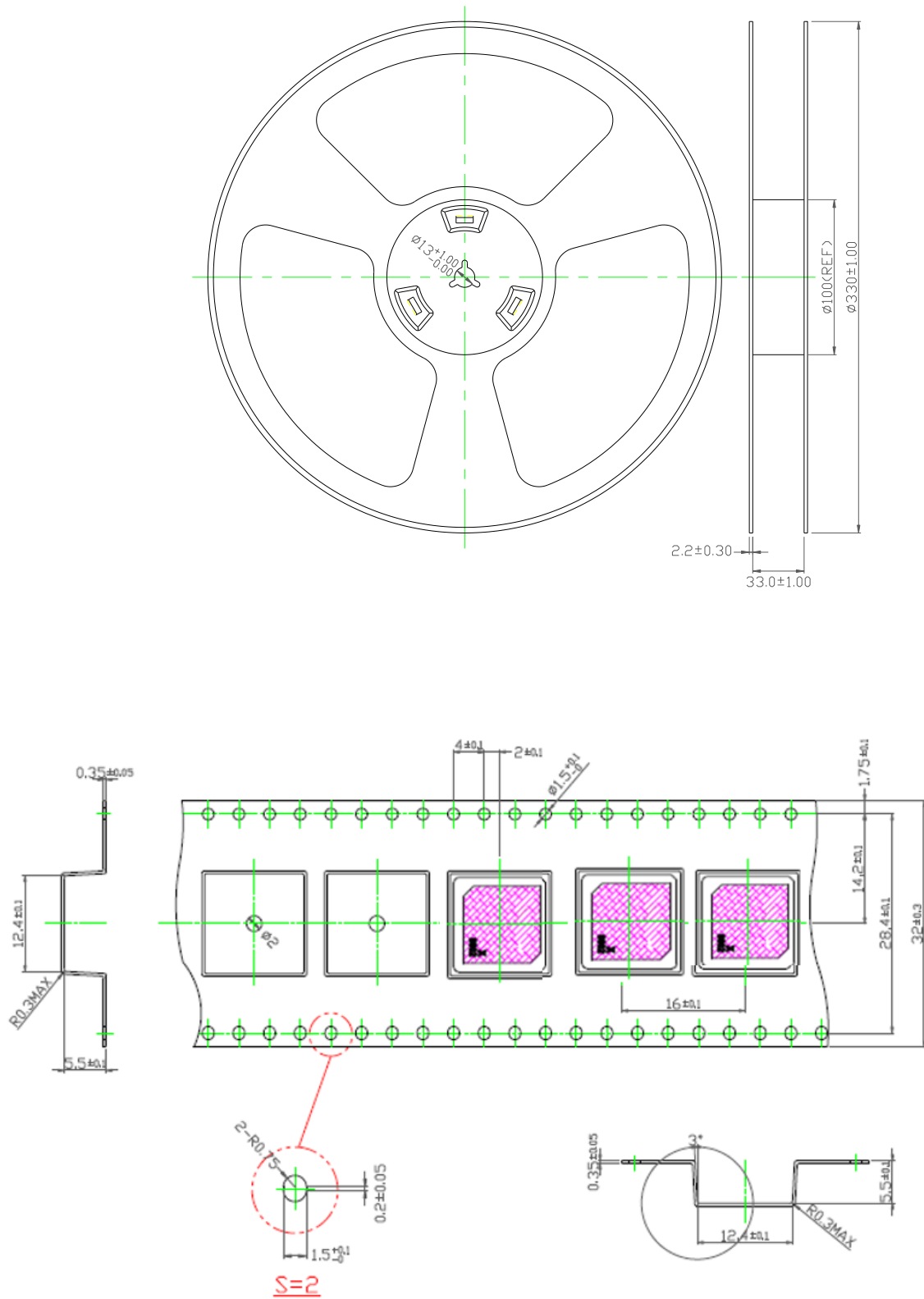

Recommended Reflow Soldering Profile

The products can be assembled following Pb-free assembly. According to the Standard **IPC/ JEDEC J-STD-020C**, the temperature profile suggested is as follow:

Phase	Profile features	Pb-Free Assembly (SnAgCu)
PREHEAT	-Temperature Min(Tsmin) -Temperature Max(Tsmax) -Time(ts) form (Tsmin to Tsmax)	150°C 200°C 60-120 seconds
RAMP-UP	Avg. Ramp-up Rate (Tsmax to TP)	3°C/second(max)
REFLOW	-Temperature(TL) -Total Time above TL (t L)	217°C 30-100 seconds
PEAK	-Temperature(TP) -Time(tp)	260°C 15-25 second
RAMP-DOWN	Rate	6°C / second max.
Time from 25°C to Peak Temperature		8 minutes max.
Composition of solder paste		96.5Sn/3Ag/0.5Cu
Solder Paste Model		SHENMAO PF606-P26

Note : All the temperature measure point is on top surface of the component, if temperature over recommend, it will make component surface peeling or damage.

The graphic shows temperature profile for component assembly process in reflow ovens

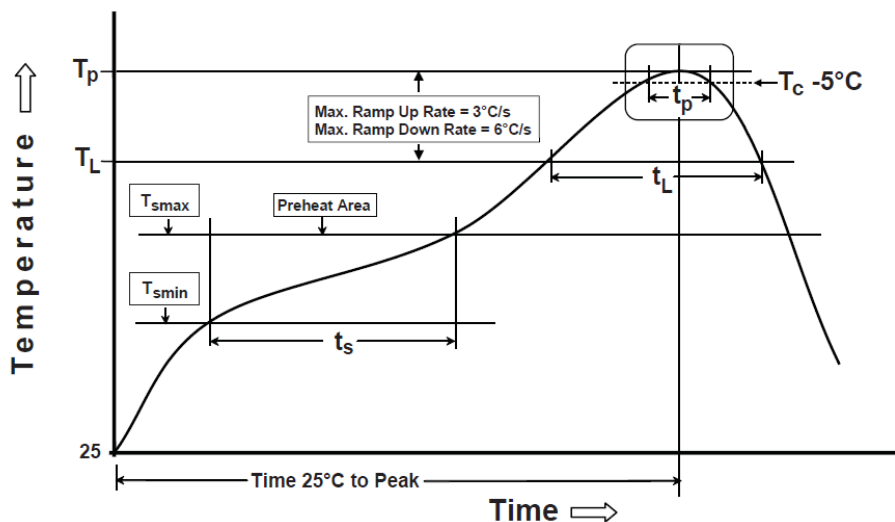

Soldering With Iron:

Soldering condition : Soldering iron temperature $270 \pm 10^\circ\text{C}$.

Apply preheating at 120°C for 2-3 minutes. Finish soldering for each terminal within 3 seconds, if soldering iron over temperature $270 \pm 10^\circ\text{C}$ or 3 seconds, it will make component surface peeling or damage.

Soldering iron can not leakage of electricity.

Recommendations of the Antenna Foot Print Tables :

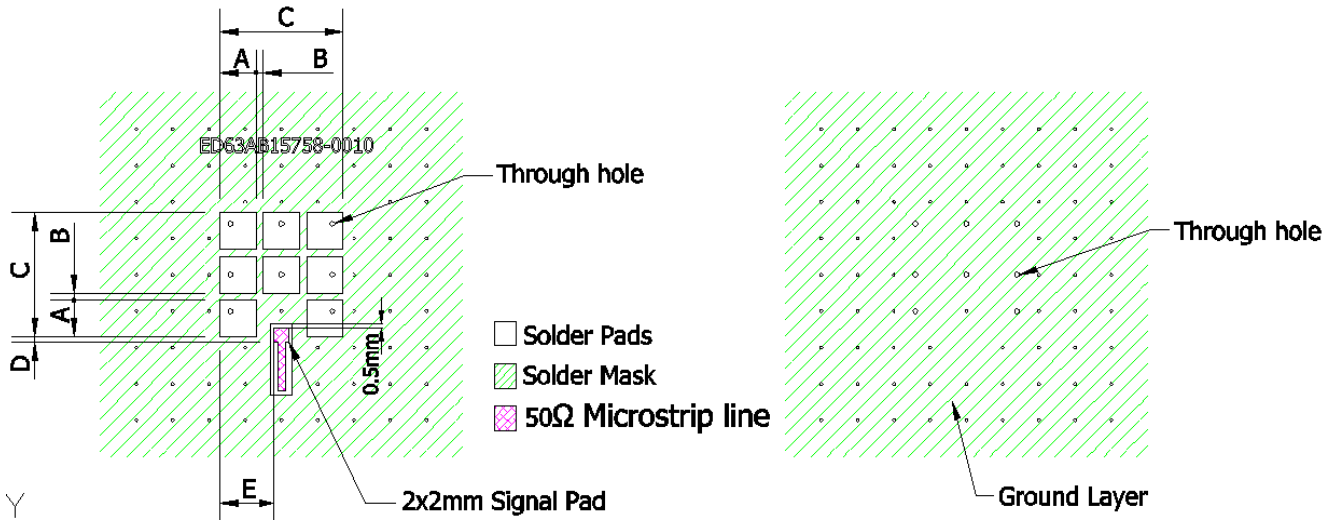

Type/Size	A	B	C	D	E
12x12x4	3±0.2	1.5±0.2	12±0.2	0.9±0.2	5±0.2

Recommendations of the PCB layout :

- It needs at least 5mm clearance between LCD panel/shielding and around antenna.
- Keep ground area around antenna as symmetrical as possible.
- It's can't be obscured metal in top of antenna space.

