

XTL1010

12.0000 MHz
Crystal Unit

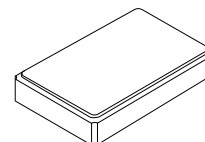

SM5032-4 Case

- **High Performance Crystal**
- **Good Frequency Stability and Reliability**
- **Miniature SMD Package**
- **Complies with Directive 2002/95/EC (RoHS)**
- **Moisture Sensitivity Level: 1**

The XTL1010 is a surface mount 5.0 x 3.2 mm crystal unit for use in wireless telecommunications devices, especially where a miniature package is needed for mobility.

Electrical Characteristics

Characteristic	Sym	Notes	Minimum	Typical	Maximum	Units
Nominal Frequency	f_o			12.0000		MHz
Mode of Oscillation			Fundamental			
Storage Temperature Range in Tape and Reel			-40		+85	°C
Operating Temperature Range			-10		+60	°C
Frequency Manufacturing Tolerance	f_L		±30 ppm @ 25 °C ±3 °C			
Frequency Stability over Operating Temperature Range			±30 ppm (referenced to the value at 25 °C)			
Equivalent Series Resistance	ESR				60	Ω
Nominal Drive Level				10		uW
Shunt Capacitance	C_o				3.0	pF
Load Capacitance	C_L			12		pF
Motional Capacitance	C_M		3.2	4.0	4.8	fF
Insulation Resistance, 100 VDC			500			MΩ
Aging, 25 °C					±1.0	ppm/yr
Standard Shipping Quantity on 330 mm (13") Reel				3000		units
Lid Symbolization (Y = year, WW = week, S = shift)			1010, <u>YWWS</u>			

Crystal Equivalent Circuit

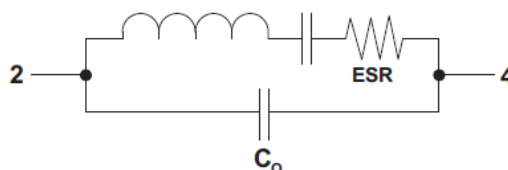

CAUTION: Electrostatic Sensitive Device. Observe precautions for handling.

NOTES:

1. The design, manufacturing process, and specifications of this device are subject to change.
2. US or International patents may apply.
3. RoHS compliant from the first date of manufacture.

SM5032-4 Case

4-Terminal Surface-Mount Seam Weld Case 5.0 x 3.2 mm Nominal Footprint

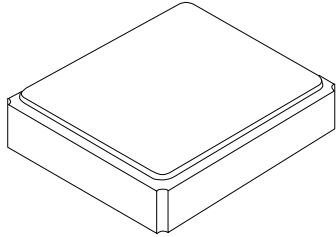

Electrical Connections

Connection	Terminals
Ground	1
Input / Output	2
Ground	3
Input / Output	4

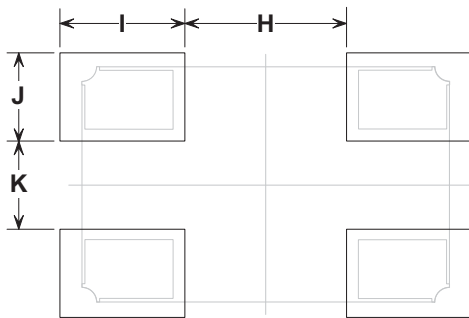

Typical PCB Land Footprint
(Top View)

Case and PCB Land Dimensions

Dimensions	Millimeters			Inches		
	Min	Nom	Max	Min	Nom	Max
A	4.90	5.00	5.10	0.193	0.197	0.200
B	3.10	3.20	3.30	0.122	0.126	0.130
C	0.70	0.80	0.90	0.028	0.031	0.035
D	2.20	2.40	2.60	0.087	0.094	0.102
E	1.10	1.20	1.30	0.043	0.047	0.051
F	1.20	1.40	1.60	0.047	0.055	0.063
G	0.70	0.80	0.90	0.028	0.031	0.035
H	2.10	2.20	2.30	0.083	0.087	0.091
I	1.60	1.70	1.80	0.063	0.067	0.071
J	1.10	1.20	1.30	0.043	0.047	0.051
K	1.10	1.20	1.30	0.043	0.047	0.051

Top View

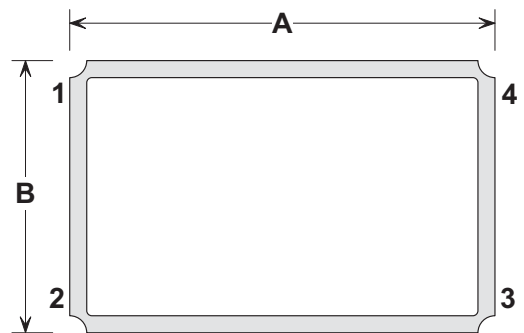

Side View

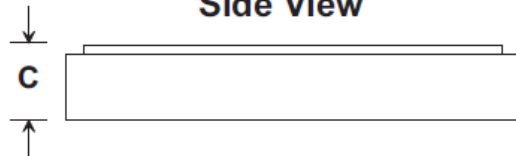

Bottom View

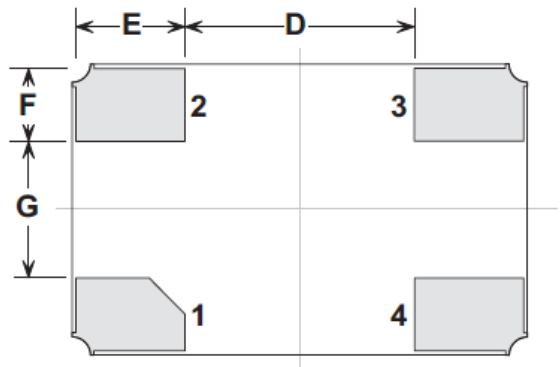

Package Orientation

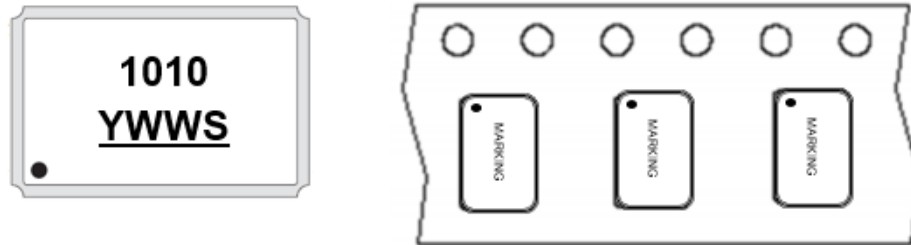

Reel Dimensions

Tape and Reel Sta

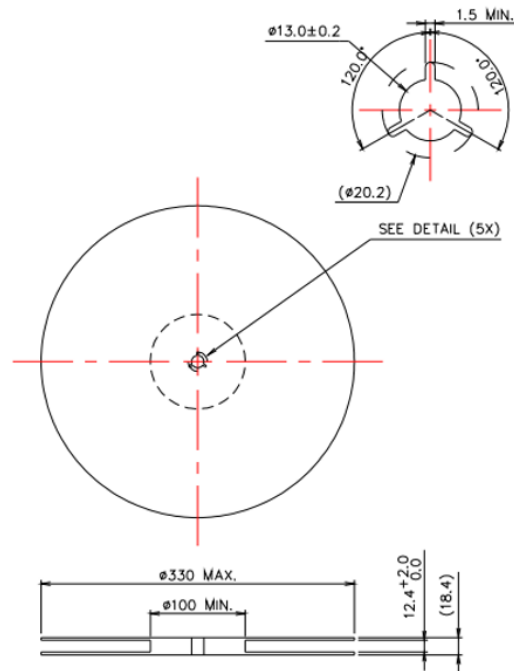

Tape Dimensions

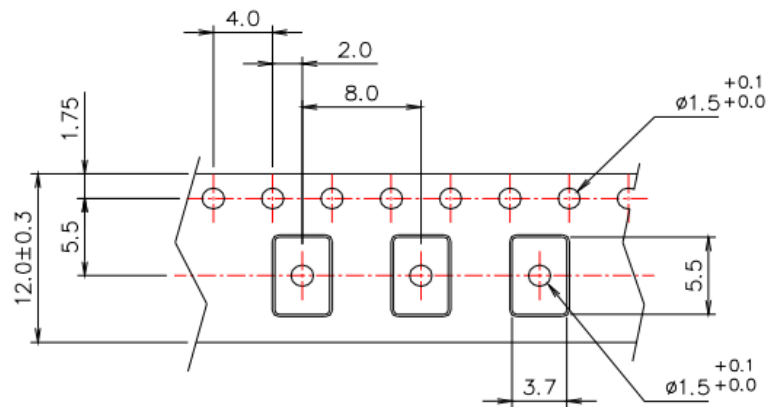

Notes:

1. Unless otherwise specified, tolerance on dimensions is ± 0.1 mm
2. Material is black conductive polystyrene
3. 10 pitch cumulative tolerance is ± 0.2 mm

Recommended Reflow Profile

1. Preheating shall be fixed at 150~180°C for 60~90 seconds.
2. Ascending time to preheating temperature 150°C shall be 30 seconds min.
3. Heating shall be fixed at 220°C for 50~80 seconds and at 260°C +0/-5°C peak (10 seconds).
4. Time: 5 times maximum.

