

SF2143B

**72.54 / 80.46 MHz
SAW Diplexer**

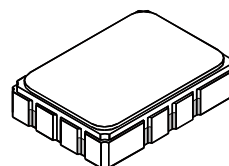

SMP-03

- **Designed for SDARS IF**
- **SAW Diplexer 72.54 MHz / 80.46 MHz**
- **5.0 X 7.0 mm Surface-mount Case**
- **Complies with Directive 2002/95/EC (RoHS)**
- **Moisture Sensitivity Level: 1**

Absolute Maximum Ratings

Rating	Value	Units
Maximum Incident Power in Passband	+10	dBm
Maximum DC Voltage Between any Two Terminals	0	VDC
Operating Temperature Range	-40 to +105	°C
Storage Temperature Range in Tape and Reel	-40 to +85	°C
Peak Solder Reflow Temperature, 10 seconds/5 cycles	260	°C

Electrical Characteristics TDM1 Filter

Characteristic	Sym	Notes	Min	Typ	Max	Units
Nominal Center Frequency	f_C			72.54		MHz
Passband Width:			3.7	4.1		MHz
	1 dB	BW_1		6.4	6.7	MHz
	15 dB	BW_{15}		7.3	7.5	MHz
	30 dB	BW_{30}		16	18	dB
Passband Minimum Insertion Loss (including matching network) at f_C	IL_{MIN}			0.6	1.3	dB _{P-P}
Amplitude Ripple, $f_C \pm 1.85$ MHz						
Attenuation Relative to Minimum Insertion Loss:			40	42		dB
	50.00 to 66.48 MHz		37	42		dB
	66.48 to 68.08 MHz		30	33		dB
	77.30 to 78.60 MHz		30	33		dB
	78.60 to 86.50 MHz		39	43		dB
	86.50 to 91.50 MHz		42	46		dB
	91.50 to 100.0 MHz			30	150	nsp _P
Group Delay Ripple						
Source Impedance, Differential				27 ohms or 200 ohms		
Load Impedance, Differential				1K ohms or 1.5K ohms		

Electrical Characteristics TDM2 Filter

Characteristic	Sym	Notes	Min	Typ	Max	Units
Nominal Center Frequency	f_C			80.46		MHz
Passband Width:			3.7	4.2		MHz
	1 dB	BW_1		6.4	6.7	MHz
	15 dB	BW_{15}		7.2	7.5	MHz
	30 dB	BW_{30}		15	18	dB
Passband Minimum Insertion Loss (including the matching network) at f_C	IL_{MIN}			0.7	1.3	dB _{P-P}
Amplitude Ripple, $f_C \pm 1.85$ MHz						
Attenuation Relative to Minimum Insertion Loss:			39	42		dB
	50.00 to 74.39 MHz		33	38		dB
	74.39 to 75.99 MHz		30	38		dB
	85.21 to 86.50 MHz		35	40		dB
	86.50 to 91.50 MHz		43	46		dB
	91.50 to 100.0 MHz			40	150	nsp _P
Group Delay Ripple						
Source Impedance, Differential				27 ohms or 200 ohms		
Load Impedance, Differential				1K ohms or 1.5K ohms		

Case Style	SMP-03 7 x 5 mm Nominal Footprint
Lid Symbolization (YY=year, WW=week, S=shift, ## = Sequence Code)	RFM, SF2143B ,YYWWS##



CAUTION: Electrostatic Sensitive Device. Observe precautions for handling.

NOTES:

1. The design, manufacturing process, and specifications of this device are subject to change.
2. US or International patents may apply.
3. RoHS compliant from the first date of manufacture.

TDM1 Amplitude and Impedance Plots

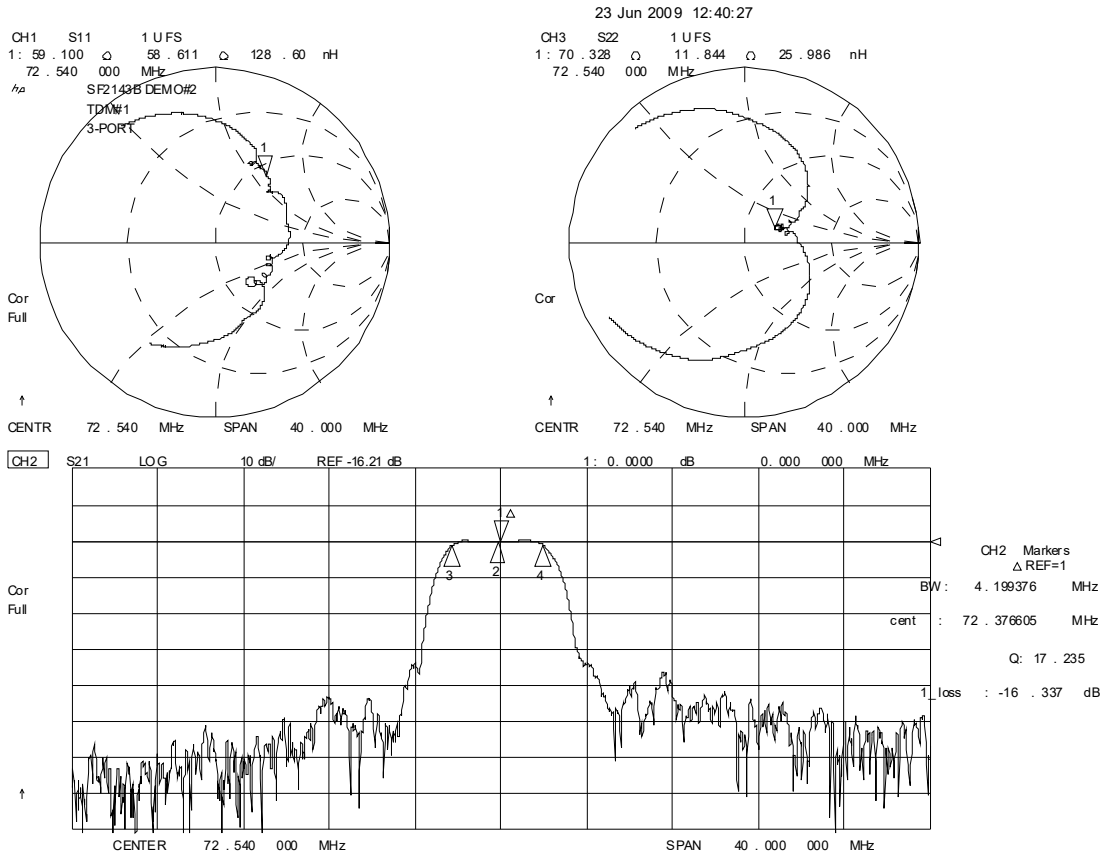

TDM2 Amplitude and Impedance Plots

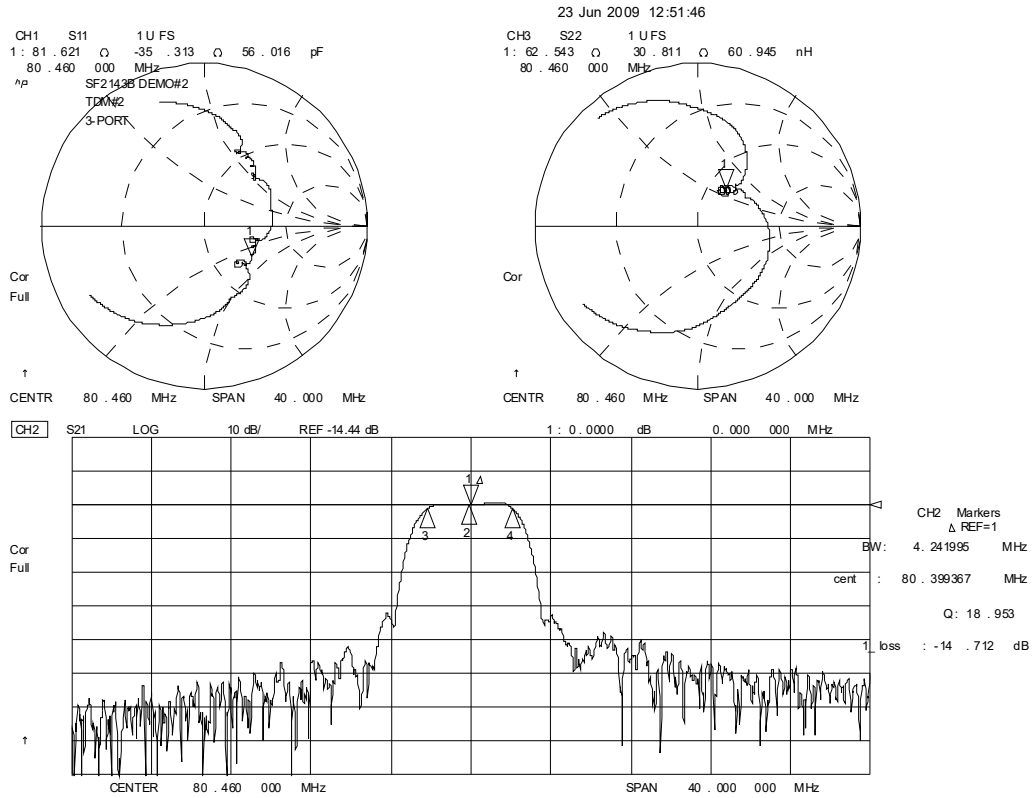

Test Circuit

SF2143B Demo Board

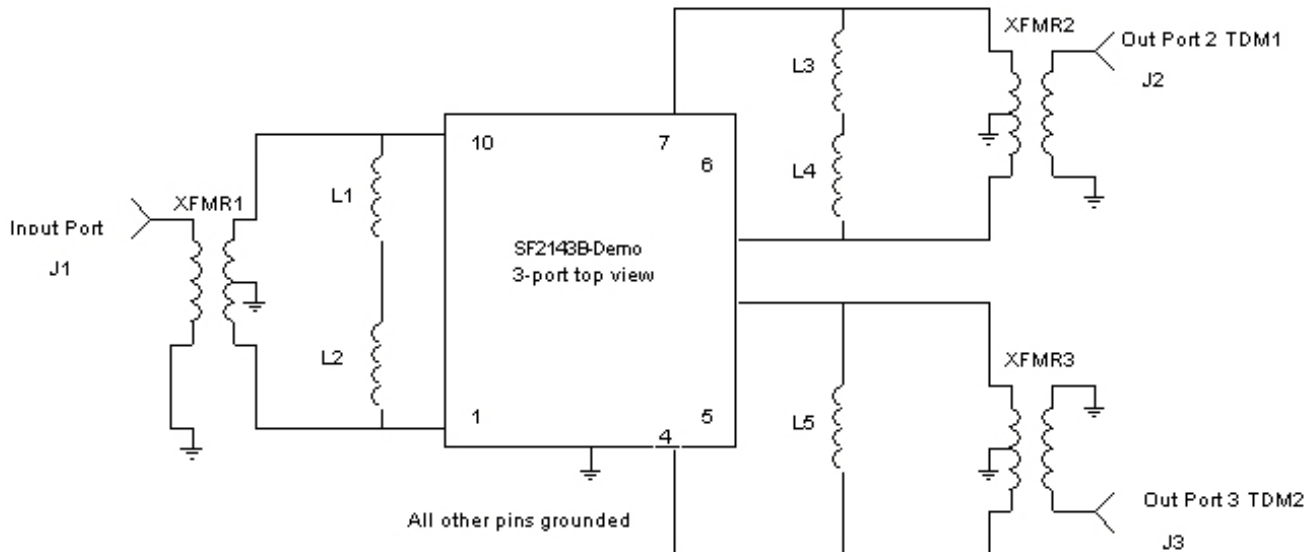

J1-J3	500-0248-002 4 hole flange SMA connector
PCB	400-1768-001 Gold 7 × 5 mm pkg PCB
XFMR2, XFMR3	501-0912-004 16:1 Transformer
XFMR1	501-0912-001 4:1 Transformer

L1	501-0782-101 100nH 0805 Ind
L2	501-0782-270 27nH 0805 Ind
L3	501-0782-390 390nH 0805 Ind
L4	501-0782-120 12nH 0805 Ind
L5	501-0782-331 330 nH 0805 Ind

SMP-03 Case

10-Terminal Ceramic Surface-Mount Case

7 x 5 mm Nominal Footprint

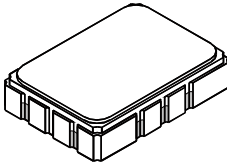

Recommended PCB Footprint

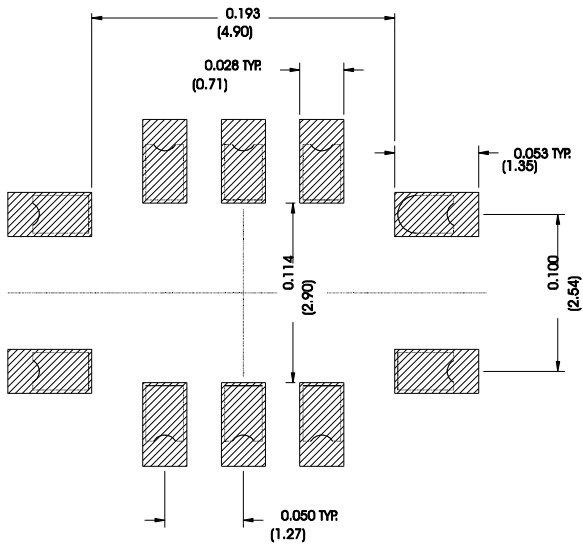

Case Dimensions

Dimension	mm			Inches		
	Min	Nom	Max	Min	Nom	Max
A	6.80	7.00	7.20	0.268	0.276	0.283
B	4.80	5.00	5.20	0.189	0.197	0.205
C	-	1.65	2.00	-	0.065	0.079
D	0.47	0.60	0.73	0.019	0.024	0.029
E	2.41	2.54	2.67	0.095	0.100	0.105
H	0.87	1.00	1.13	0.034	0.039	0.044
J	4.87	5.00	5.13	0.192	0.197	0.202
K	2.87	3.00	3.13	0.113	0.118	0.123
P	1.14	1.27	1.40	0.045	0.050	0.055

Electrical Connections

Connection		Terminals
Port 1	Input	1
	Input	10
Port 2	Output TDM1	6
	Output TDM1	7
Port 3	Output TDM2	4
	Output TDM2	5
Ground		All others

Materials

Solder Pad Plating	0.3 to 1.0 μm Gold over 1.27 to 8.89 μm Nickel
Lid Plating	2.0 to 3.0 μm Nickel
Body	Al_2O_3 Ceramic

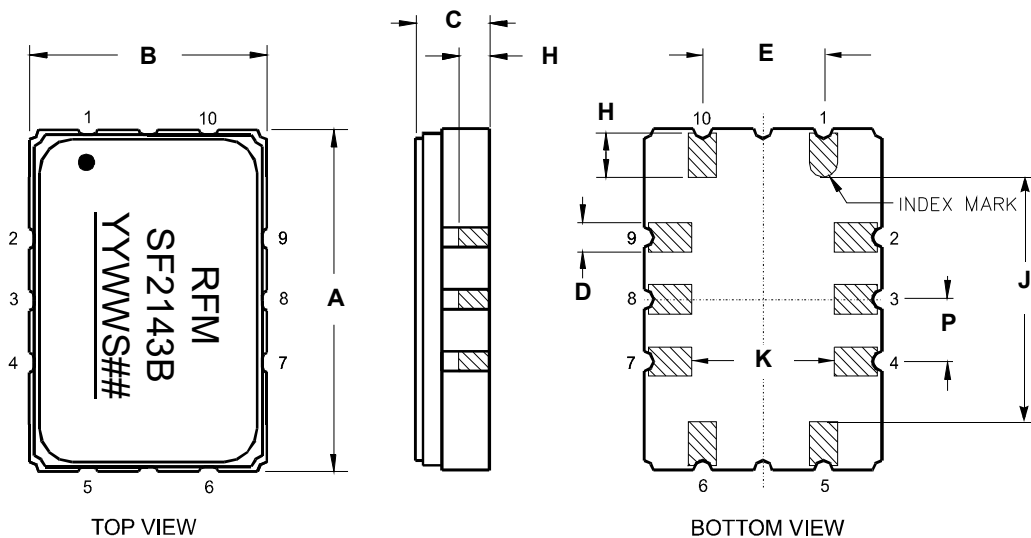

Tape and Reel Specifications

Tape and Reel Standard per ANSI/EIA-481

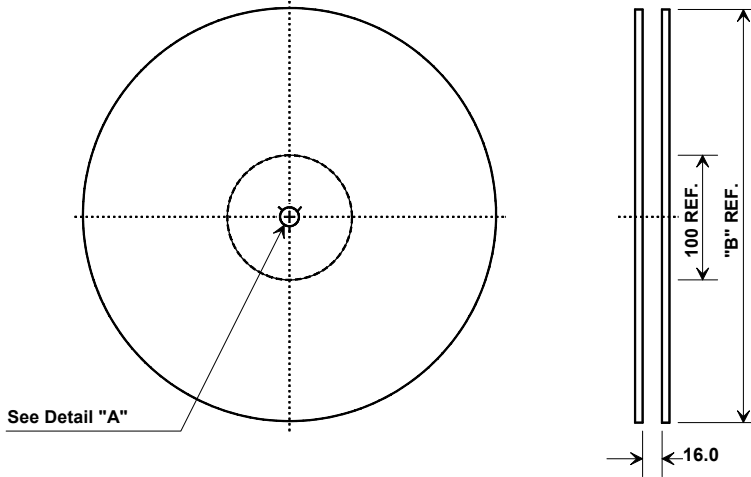

"B"		Quantity Per Reel
Inches	millimeters	
7	178	500
13	330	2000

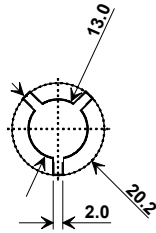

COMPONENT ORIENTATION and DIMENSIONS

Carrier Tape Dimensions	
Ao	5.5 mm
Bo	7.5 mm
Ko	2.0 mm
Pitch	8.0 mm
W	16.0 mm

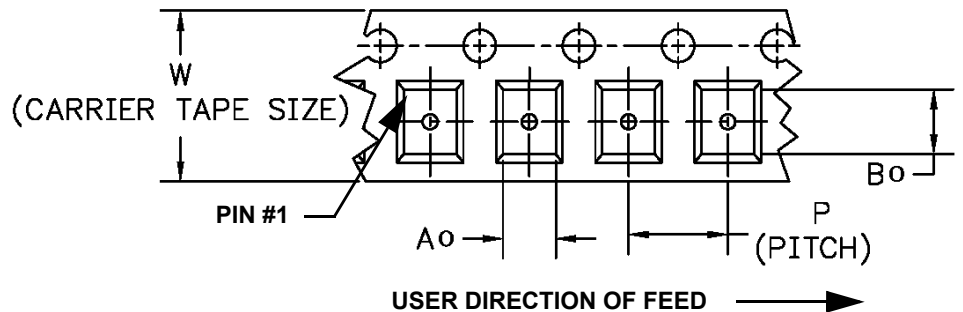
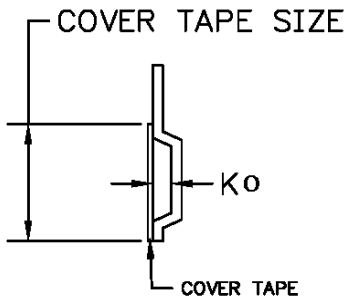

Recommended Reflow Profile

1. Preheating shall be fixed at 150~180°C for 60~90 seconds.
2. Ascending time to preheating temperature 150°C shall be 30 seconds min.
3. Heating shall be fixed at 220°C for 50~80 seconds and at 260°C +0/-5°C peak (10 seconds).
4. Time: 5 times maximum.

