



RFM Integrated Device, Inc.

PRODUCT SPECIFICATION

Part Number:
SARBC433M95BXL0R12

SAW Resonator, 433.950 MHz,
+/-50 kHz, IL 2.5 dB

1. SCOPE

This product specification is applied to SARBC433M95BXL0R12, the 400MHz range SAW resonator for oscillator.

Please contact us when using this product for any other applications than described in above.

Country of origin : TAIWAN (TAI-SAW TECHNOLOGY Co., Ltd.)
or CHINA (TAI-SAW TECHNOLOGY (WUXI) INC.)

2. CUSTOMER PART NUMBER

Part No.		Specification No.	
----------	--	-------------------	--

3. RFMi PART NUMBER

SARBC433M95BXL0R12	: TAPING PACKING (2000pcs)
--------------------	----------------------------

4. DIMENSIONS

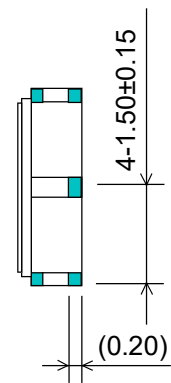
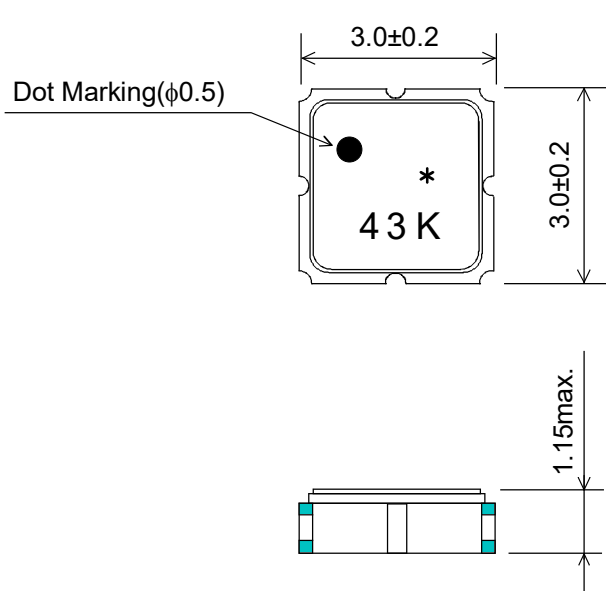

Marking : Laser Printing

* : EIAJ Code

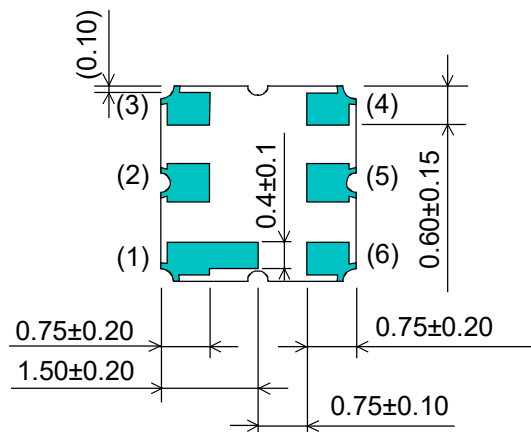

Terminal(Surface) : Au

thickness 0.3...1.0μm
(Typ. 0.6μm)

Terminal(Base) : Ni

thickness 2.0...8.0μm
(Typ. 3.5μm)

Terminal Assignments

(2)(5) : Input
Others : Ground

Weight : 32±5mg

Coplanarity : 0.1mm max.

Unit : mm

5. MAXIMUM RATINGS

5.1	Withstanding Voltage for short term between the terminals	10V (Minimum Resistance; 100MΩ at 25±2°C)
5.2	D. C. Voltage between the terminals	3V at 25±2°C
5.3	A. C. Voltage between the terminals	10V p-p
5.4	Amplitude Level between the terminals	0.2mW
5.5	Operating Temperature Range	-40...+85°C
5.6	Storage Temperature Range	-40...+85°C

6. ELECTRICAL CHARACTERISTICS (25±2°C)

	Item	Specifications
6.1	Resonant Frequency (at center frequency of 0.5dB bandwidth)	433.950±0.050MHz
6.2	Resonant Loss (at peak point)	2.5dB max.
6.3	Parallel Capacitance at 1MHz One terminal is connected to ground.	2.1±0.5pF

* Unless otherwise specified, all the tests shall be carried out on the standard atmospheric conditions.
[Temperature: 5...35°C, Humidity: 45...85% R.H.]

Test Circuit

(a) Measurement Circuit

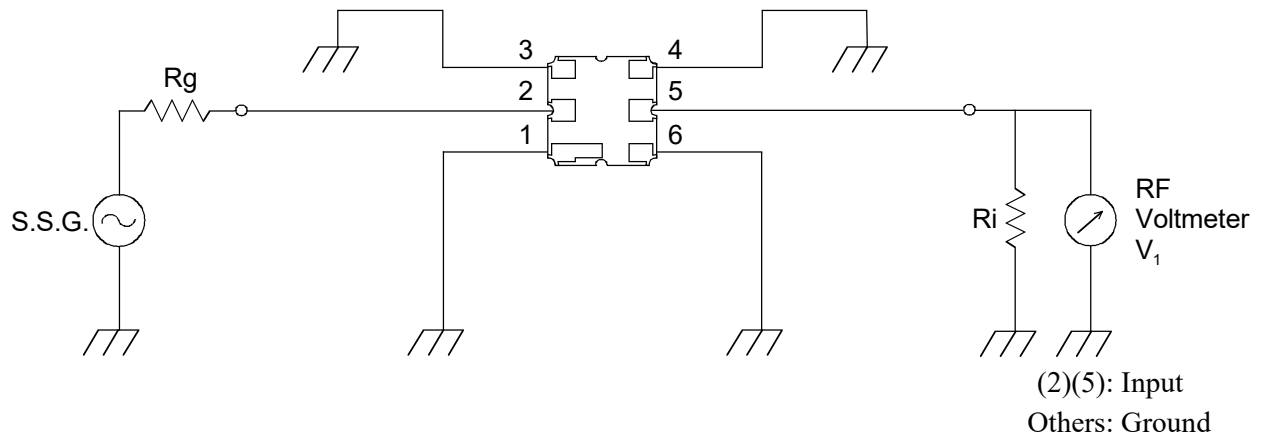

R_g : 50Ω (Internal resistance of S.S.G.)

R_i : 50Ω (Input impedance of network analyzer or spectrum analyzer)

Resonant Loss or Insertion Loss = $20 \log (V_2 / V_1)$ [dB]

V_1 : Output Voltage of Test Circuit (a)

V_2 : Output Voltage of Test Circuit (b)

Item	Specifications
Resonant Frequency (at center frequency of 0.5dB bandwidth)	433.950±0.070MHz
Resonant Loss (at peak point)	2.5dB max.
Parallel Capacitance at 1MHz One terminal is connected to ground.	2.1±0.5pF

Table 1

Item	Specifications
Resonant Frequency (at center frequency of 0.5dB bandwidth)	433.950±0.110MHz
Resonant Loss (at peak point)	3.0dB max.
Parallel Capacitance at 1MHz One terminal is connected to ground.	2.1±0.5pF

Table 2

Item	Specifications
Resonant Frequency (at center frequency of 0.5dB bandwidth)	433.950±0.185MHz
Resonant Loss (at peak point)	3.0dB max.
Parallel Capacitance at 1MHz One terminal is connected to ground.	2.1±0.5pF

Table 3

Reflow Profile

• Profile A

- 1) Preheating shall be fixed at 140...160°C for 60...90 seconds.
- 2) Ascending time to preheating temperature 150°C shall be 30 seconds minimum.
- 3) Heating shall be fixed at 200°C for 50...60 seconds and at 230±10°C peak.

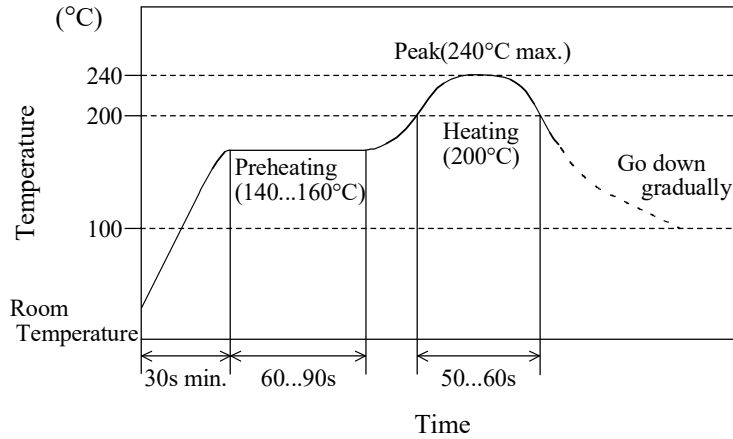

• Profile B

- 1) Preheating shall be fixed at 160...180°C for 60...90 seconds.
- 2) Ascending time to preheating temperature 170°C shall be 40 seconds minimum.
- 3) Heating shall be fixed at 220°C for 50...60 seconds and at 255±5°C peak.

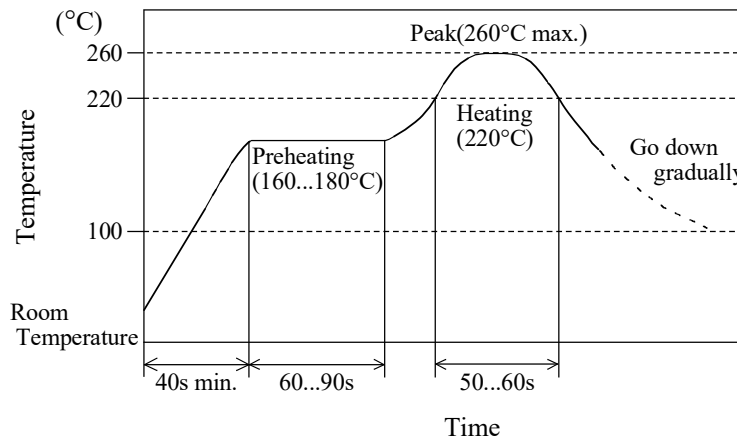

Recommended Land Pattern

1) Recommended land pattern is as follows.

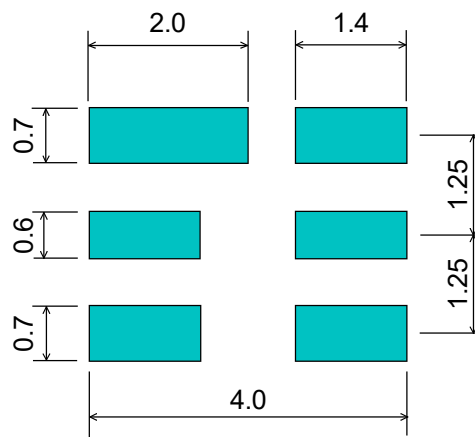

■ : Land Pattern
Unit : mm

8. TAPING METHOD OF PLASTIC TAPE PACKAGE

8.1 The components are packed to be prevented from being damaged. Part number, quantity and inspection number are indicated on each minimum packing unit.

8.2 Dimensions of Plastic Tape See Figure. 2.

8.3 Taping Method

- 1) The tape shall be wound clockwise. (The feeding holes shall be to the right side when the tape is pulled toward user.)
- 2) Cover tape shall not cover the feeding holes of cavity tape or overlap the edge of cavity tape.
- 3) Trailer tape shall be 160...190 mm and leader cavity shall be 80...120 mm (refer to Figure. 1.)
- 4) The tip of the cover tape shall be adhered to the side of reel with adhesive tape (50...120 mm: Reference value).
- 5) The cover tape peel strength force shall be 0.2...0.6N (Reference value) which measured at 170 degrees with respect to the carrier tape.
- 6) The orientation is ruled as Figure. 2 shows.
- 7) All the filters shall be packed continuously into the tape without vacant cavities except the leader cavity and trailer tape area.
- 8) A reel shall contain 2000 pcs of filters.
(Please place the order with 2000 pcs times integer number. In case of small quantity shipment, bulk packing may be applied.)
- 9) Cover tape and cavity tape are made of anti-static material.
- 10) Part number, customer part number, quantity and inspection lot number shall be marked on each reel. (The reel side containing the label will visible when the reel is oriented in a direction that dispenses the tape from the top of the reel and in a clockwise direction.)
- 11) The product which has ROHS-Y<*> mark on the packaging label is compliance with RoHS directives. The alphabet in blank <*> will be changed A to B, B to C, and so on with every revision of the RoHS directives. Please refer to the document, "The Marking for the directives on the restriction of the hazardous substances' use," to check the directives corresponding to alphabets in <*>.

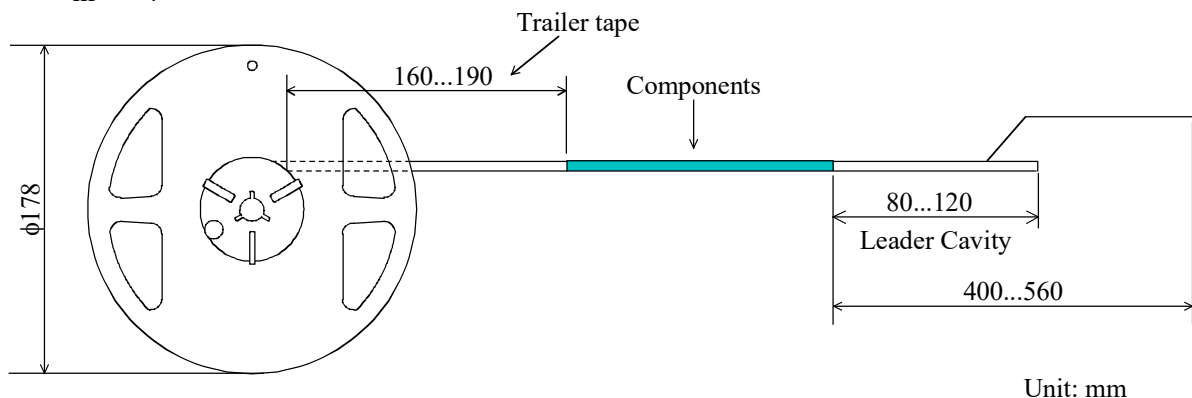
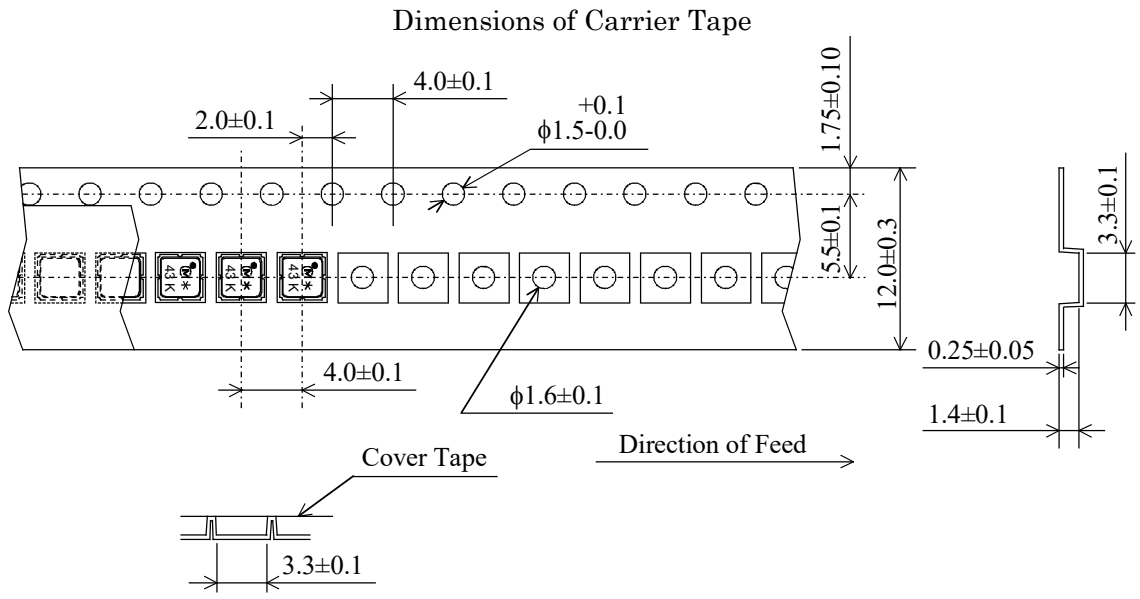

Figure. 1



Unit: mm

- The marked part number faces the cover tape side.

Figure. 2

Dimensions of Reel

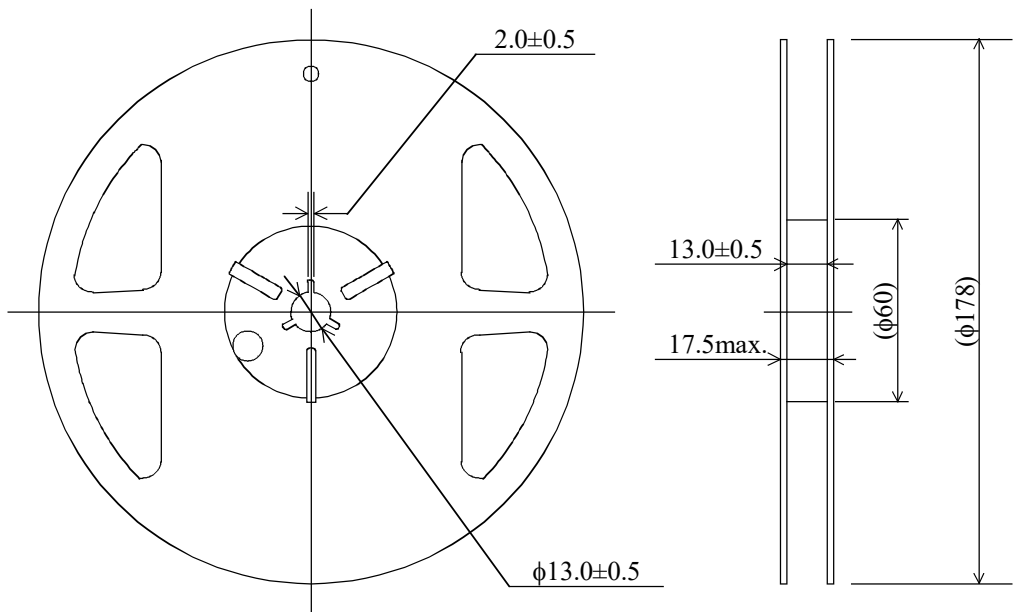

Unit: mm

Figure. 3

9. NOTICE

9.1 Usage Conditions

- 1) Use this component within operating temperature range. It might not meet the specification of electrical performance out of operating temperature range. Usage on the condition of under -40°C or over $+85^{\circ}\text{C}$ might cause degradation or destruction of the component. Even a short time usage on such conditions might cause degradation of reliability.

- 2) This product is designed for use of electrical equipment in the standard environment (temperature, humidity, atmospheric pressure etc.) Do not use in the following environments, since it causes degradation of characteristics and reliability.
 - Ambient air containing corrosive gas (Cl_2 , H_2S , NH_3 , SO_x , NO_x , etc.)
 - Ambient air containing combustible gas and substance with high volatility
 - In dusty place
 - In the places where the water splashes or precipitates
 - Under direct sunlight
 - In the places under the strong influence of static electricity or electric fieldContact us before using the component in such conditions.

- 3) This component can not be used in liquid (water, oil, chemical solution, organic solvents, etc.)

- 4) Apply electrical power lower than specified in the specification. When the component is used with higher rating power than specified in the specification, it might cause degradation or destruction of the component. Even if a short time, it might cause degradation of reliability under such a condition.

- 5) Do not let the component contact with other components, since its coating is not insulated.

9.2 Storage Conditions

- 1) Keep the component in the package or sealed container on the following conditions.
[Temperature: $-10\dots+40^{\circ}\text{C}$, Humidity: 30...85% R.H.]
Examine solderability before using this component, after longer than 6 months storage since it might cause degradation of solderability. Notice that long-term storage might cause discoloration.

- 2) To keep solderability of outer-electrode, do not store in the following environments.
 - Ambient air containing corrosive gas (Cl_2 , H_2S , NH_3 , SO_x , NO_x , etc.)
 - Ambient air containing combustible gas and substance with high volatility
 - In dusty place
 - In the places where the water splashes or precipitates
 - Under direct sunlight
 - In the places under the strong influence of static electricity or electric fieldContact us before using the component in such conditions.

- 3) Do not open the package until usage.

9.3 Soldering Conditions

- 1) Solder on the following condition. Contact us before soldering this component on conditions other than following since it might cause destruction.
 - a. Soldering with soldering iron
 - Preheating condition : 150±20°C, 60 seconds min.
 - Temperature at the tip of the soldering iron : 260±10°C or 350±5°C
 - Duration : 3 seconds max.
 - Diameter at the tip of the soldering iron : φ3mm max.
 - Power of soldering iron : 30W max.Avoid the contact with iron other than back or side terminals part.
 - b. Reflow soldering
 - Solder on the reflow soldering condition specified in this specification
- 2) Use land pattern recommended in this specification, since excess solder might cause destruction of chip by mechanical stress to supply too much solder.
- 3) Use rosin flux. Do not use strong acid flux [ex. Flux with more than 0.2wt% Halogen compound content (converted to chlorine content.)]
- 4) Use JIS-Z-3282 H63A, H60A, H50A solder or Lead free solder (Sn-3.0Ag-0.5Cu). Contact us before using other solders than above.
- 5) Solder with reflow soldering. Soldering with soldering iron shall be soldered on the condition specified in this specification. Since the lack of preheating gives this component rapid temperature change, it might cause degradation and destruction. Contact us before using the component on other conditions than specified in this specification.
- 6) Notice that the duration of soldering with soldering iron must be considered to be accumulated time, when soldering is repeated.
- 7) Use this component after examining that the outer electrodes are smoothly covered with solder thicker than 0.1mm.

9.4 Cleaning Conditions

- 1) Isopropyl alcohol and ethyl alcohol can be used for cleaning. Contact us before using other cleaning solvents than above. Do not use flon, trichloroethane etc in the point of view to protect for global environment.
- 2) Clean this component after ensuring that the temperature of the component is room temperature, since rapid temperature change by cleaning after reflow soldering might cause degradation or destruction.
- 3) Do not use ultrasonic cleaning, since ultrasonic vibration might cause degradation or destruction.
- 4) Dry this component immediately after cleaning.
- 5) In the case that cleaning process is included in the manufacturing process, examine the influence to the performance of the component with mounting on PCB before use.

9.5 Handling Conditions

- 1) Notice that it might cause destruction to apply larger shock than specified in the specification while handling.
- 2) Notice that it might cause reliability degradation to apply excessive shock or vibration during transportation.
- 3) Do not apply any shock or pressure to this component during transportation when the component is on PCB.
- 4) Do not apply static electricity or excessive voltage while assembling and measuring, since it might cause degradation or destruction to apply static electricity to this component.
- 5) Do not handle this component with bare hand.

9.6 Mounting Conditions

- 1) Mount this component not to apply a stress caused by warp or bend of PCB.
- 2) Abraded positioning claw, pick-up nozzle, etc of component placement machine might apply excessive shock on the component on PCB and cause destruction. Keep the maintenance which is instructed on each machine regularly to prevent the component from these kinds of troubles.
- 3) Mount all terminals, or terminal strength might be degraded.
- 4) Mount the component on PCB with no space between component and PCB.

9.7 Limitation of Applications

Please contact us before using our products for the applications listed below which require especially for the prevention of defects which might directly cause damage to the third party's life, body or property.

- a. Aircraft equipment
- b. Aerospace equipment
- c. Undersea equipment
- d. Nuclear control equipment
- e. Medical equipment
- f. Transportation equipment (vehicles, trains, ships, etc.)
- g. Traffic signal equipment
- h. Disaster prevention / crime prevention equipment
- i. Data - processing equipment
- j. Application of similar complexity and / or reliability requirements to the applications listed in the above

NOTE

- 1) Please make sure that your product has been evaluated in view of your specifications with our product being mounted to your product.
- 2) You are requested not to use our product deviating from the agreed specifications.
- 3) We consider it not appropriate to include any terms and conditions with regard to the business transaction in the product specifications, drawings or other technical documents. Therefore, if your technical documents as above include such terms and conditions such as warranty clause, product liability clause, or intellectual property infringement liability clause, they will be deemed to be invalid.