

- **RF Filter for Mobile Communication Applications**
- **Low Insertion Loss**
- **3.0 x 3.0 x 1.3 mm Surface-mount Case**
- **No Matching Circuit Required**
- **Complies with Directive 2002/95/EC (RoHS)**
- **Moisture Sensitivity Level: 1**

SF1183E

**881.5 MHz
SAW Filter**

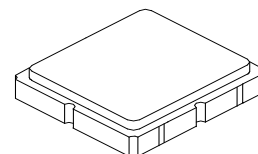

SM3030-6

Absolute Maximum Ratings

Rating	Value	Units
Maximum Input Power	+10	dBm
Maximum DC Voltage	5	VDC
Operable Temperature Range	-45 to +125	°C
Specification Temperature Range	-30 to +85	°C
Storage Temperature Range	-40 to +85	°C
Max Soldering Profile	265 °C for 10 s	

Electrical Characteristics

Characteristic	Sym	Notes	Min	Typ	Max	Units
Nominal Operating Frequency	f_c			881.5		MHz
Insertion Loss, 869 to 894 MHz	IL			2.3	3.0	dB
Amplitude Ripple, p-p, 869 to 894 MHz				0.8	1.5	
Attenuation (Reference level from 0 dB)						dB
DC to 824 MHz			40	50		
824 to 849 MHz			35	47		
970 to 997 MHz			35	64		
997 to 1150 MHz			40	60		
1150 to 1500 MHz			30	51		
1500 to 2000 MHz			25	41		
2000 to 3000 MHz			20	27		
VSWR, 869 to 894 MHz				1.6:1	2.0:1	MHz
Source impedance	Z_S			50		Ω
Load impedance	Z_L			50		Ω

Single Ended Input / Output, Impedance match	No matching network required for operation at 50 ohms
Case Style	SM3030-6 3 x 3 mm Nominal Footprint
Lid Symbolization (Y=year, WW=week, S=Shift)	A92 <u>YWWS</u>

Electrical Connections

Connection	Terminals
Input	2
Output	5
Ground	All others

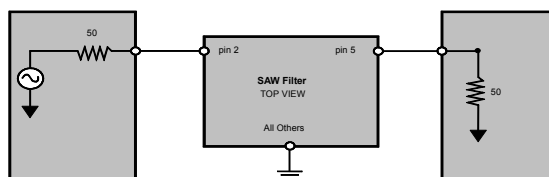

CAUTION: Electrostatic Sensitive Device. Observe precautions for handling.

NOTES:

1. The design, manufacturing process, and specifications of this device are subject to change.
2. US or International patents may apply.
3. RoHS compliant from the first date of manufacture.

Filter Frequency Response Plots

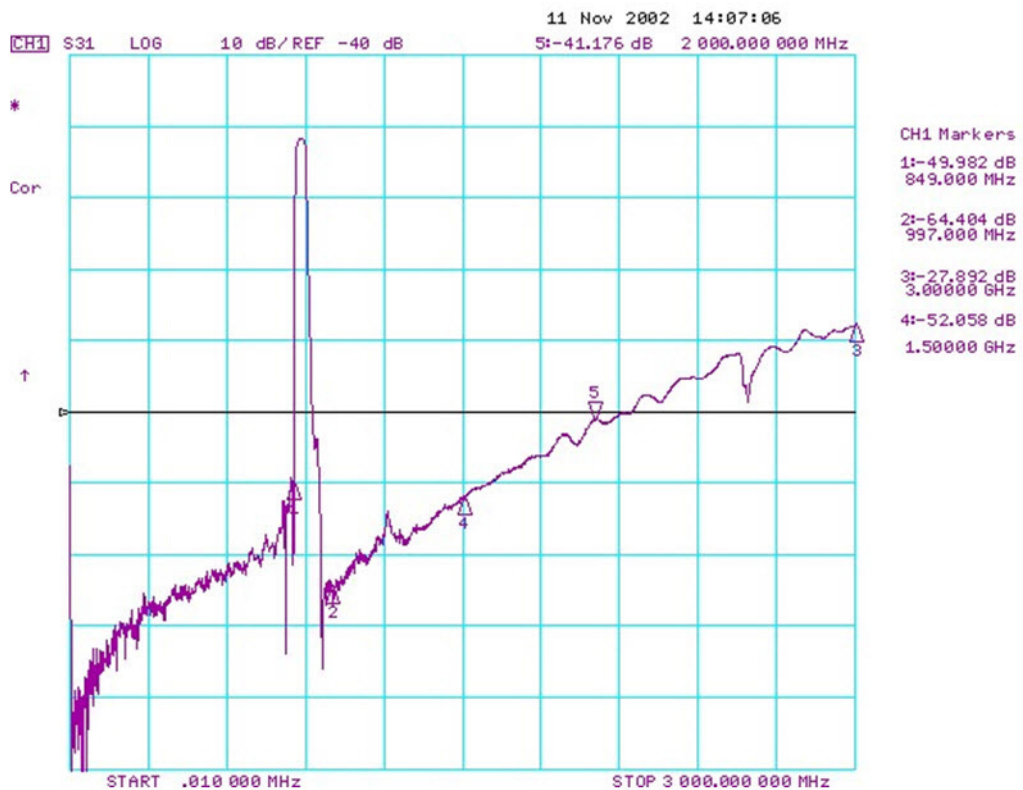
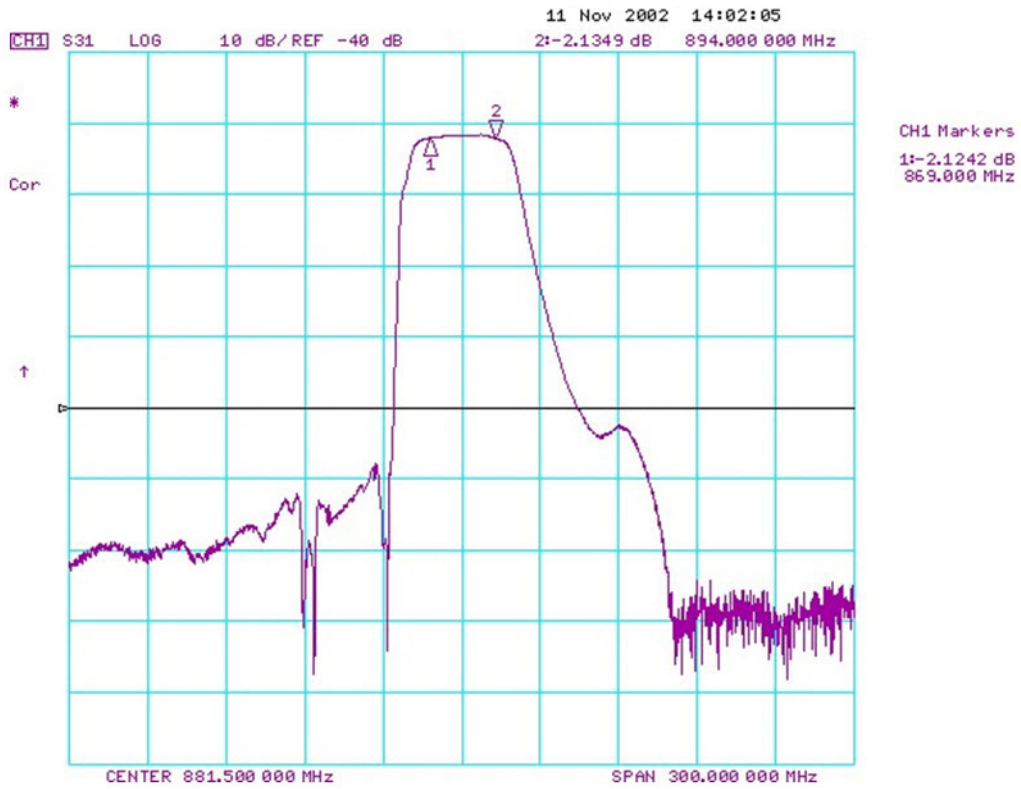

VSWR and Impedance Plots

S11

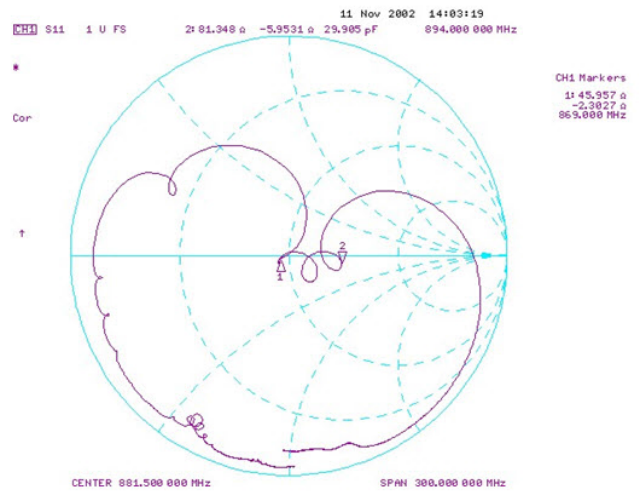
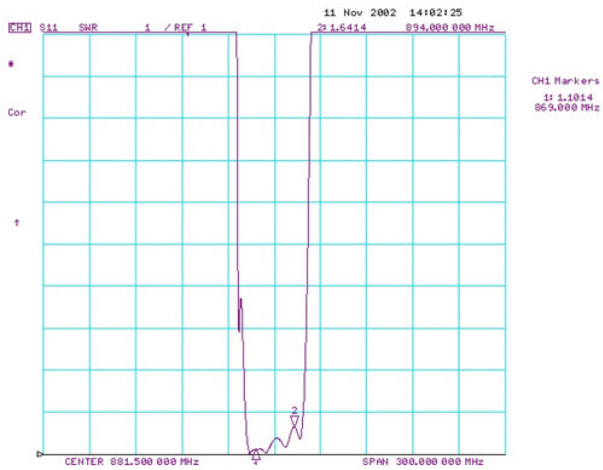

S22

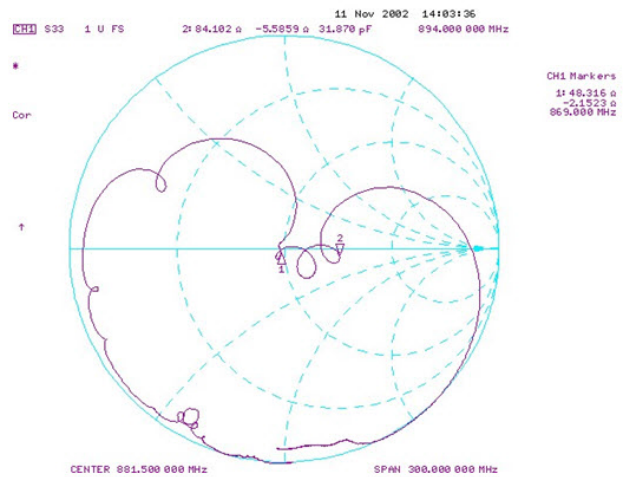
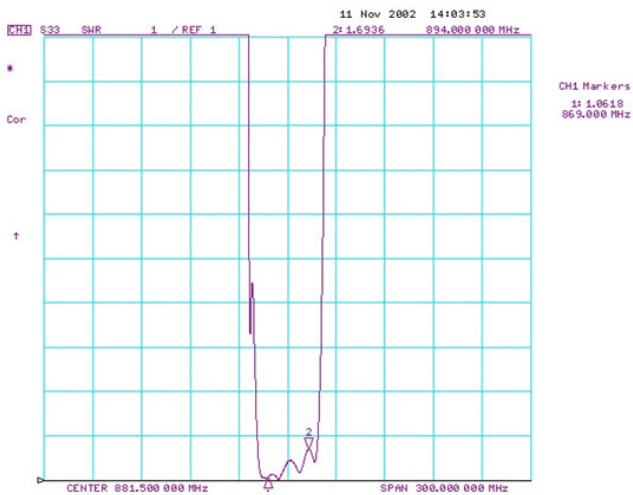

Tape and Reel Specifications

Tape and Reel Standard per ANSI/EIA-481

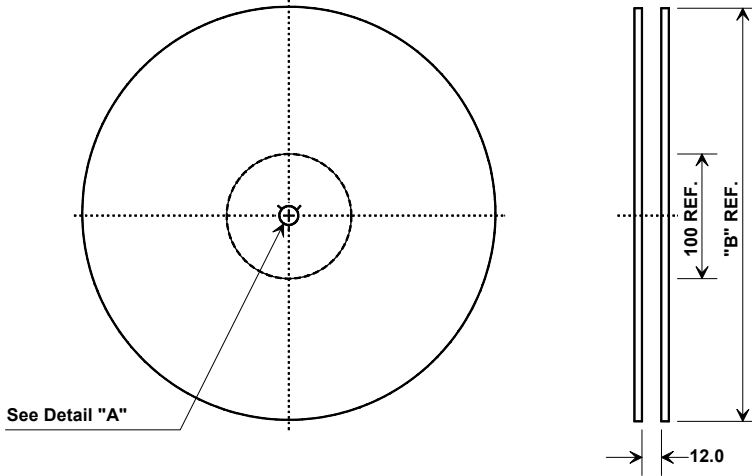

"B" Nominal Size		Quantity Per Reel
Inches	millimeters	
7	178	500
13	330	3000

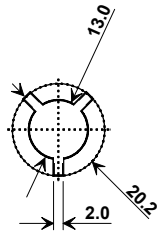

COMPONENT ORIENTATION

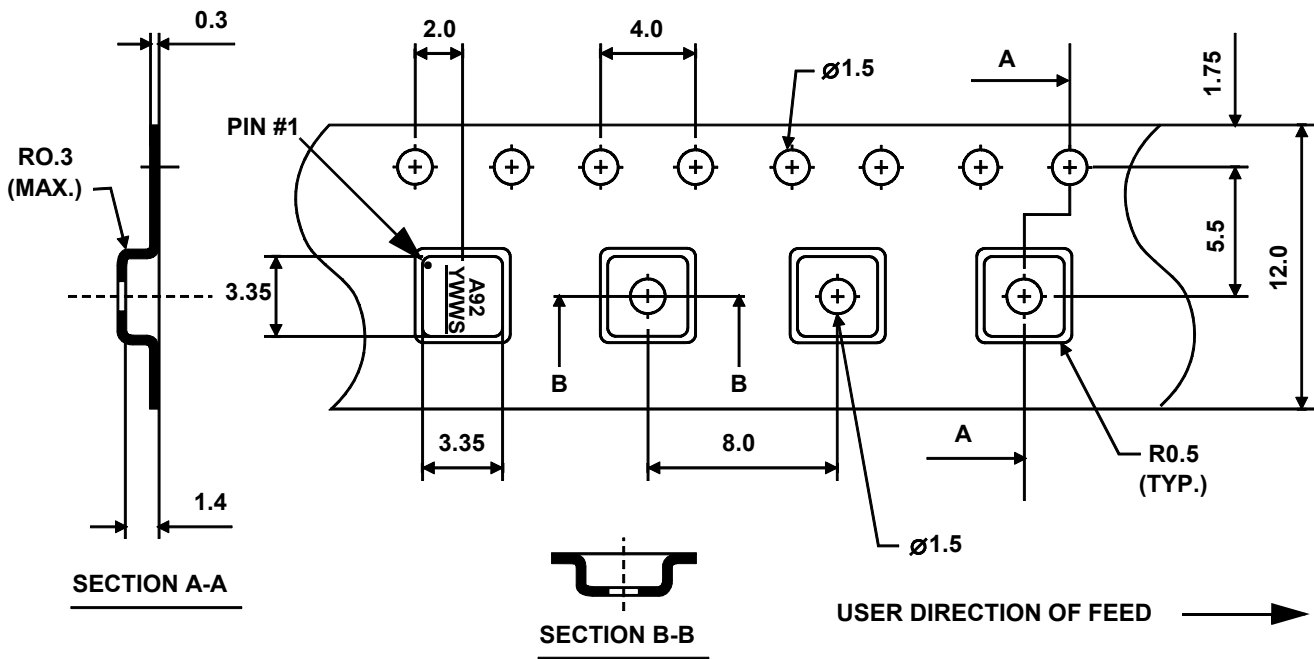

SM3030-6 Case

6-Terminal Ceramic Surface-Mount Case 3.0 X 3.0 mm Nominal Footprint

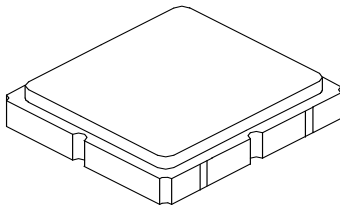

Case Dimensions

Dimension	mm			Inches		
	Min	Nom	Max	Min	Nom	Max
A		3.0			0.118	
B		3.0			0.118	
C		1.3			0.051	
D		0.9			0.035	
E		2.54			0.100	
F		1.6			0.063	
G		0.85			0.033	
H		1.5			0.059	
I		0.6			0.024	
J		1.3			0.051	

Electrical Connections

Connection		Terminals
Port 1	Single Ended Input	2
Port 2	Single Ended Output	5
	Ground	All others
Single-ending Operation Only		
Dot indicates Pin 1		

TOP VIEW

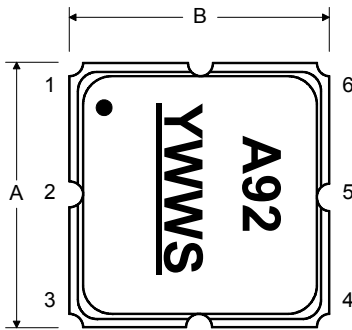

BOTTOM VIEW

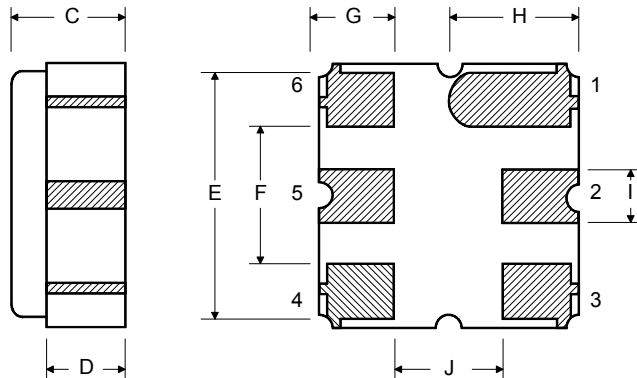

Recommended Reflow Profile

1. Preheating shall be fixed at 150~180°C for 60~90 seconds.
2. Ascending time to preheating temperature 150°C shall be 30 seconds min.
3. Heating shall be fixed at 220°C for 50~80 seconds and at 260°C+0/-5°C peak (10 seconds).
4. Time: 5 times maximum.

