

- **Low Insertion Loss SAW RF Filter**
- **3.0 x 3.0 x 1.3 mm Surface-Mount Case**
- **No Matching Circuit Required**
- **Complies with Directive 2002/95/EC (RoHS)**
- **Moisture Sensitivity Level: 1**

#### Absolute Maximum Ratings

Rating	Value	Units
Input Power Level	+10	dBm
DC Voltage on any Non-ground Terminal	3	Volts
Operating Temperature Range	-20 to +70	°C
Storage Temperature Range in Tape and Reel	-30 to +85	°C
Maximum Soldering Profile, 5 Cycles/10 seconds Maximum	265	°C

**SF2161E**

**2650 MHz  
SAW Filter**

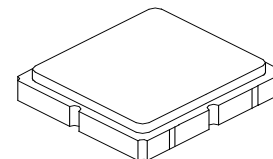

**SM3030-6**

#### Electrical Characteristics

Characteristic	Sym	Notes	Min	Typ	Max	Units
Center Frequency	$f_c$	1		2650		MHz
Insertion Loss	IL			2.0	3.5	MHz
Amplitude Ripple, 2615 to 2685 MHz				0.9	2.5	dB <sub>P-P</sub>
Attenuation Referenced to 0 dB:						
DC to 2300 MHz			23.0	27.5		dB
2300 to 2500 MHz			25.0	32.0		
2800 to 4000 MHz			30.0	34.0		
4000 to 5000 MHz			20.0	32		
VSWR, 2615 to 2685 MHz				1.6:1	2.3:1	
Source Impedance	$Z_S$			50		$\Omega$
Load Impedance	$Z_L$			50		$\Omega$

Single-Ended Input / Output Impedance Match	No matching network required for operation at 50 ohms
Case Style	SM3030-6 3 x 3 mm Nominal Footprint
Lid Symbolization, Y=year, WW=week, S=shift	848 YWWS

#### Electrical Connections

Connection	Terminals
Input	2
Output	5
Ground	All others



**CAUTION: Electrostatic Sensitive Device. Observe precautions for handling.**

#### NOTES:

1. The design, manufacturing process, and specifications of this device are subject to change.
2. US or International patents may apply.
3. RoHS compliant from the first date of manufacture.

# Broadband Filter Response

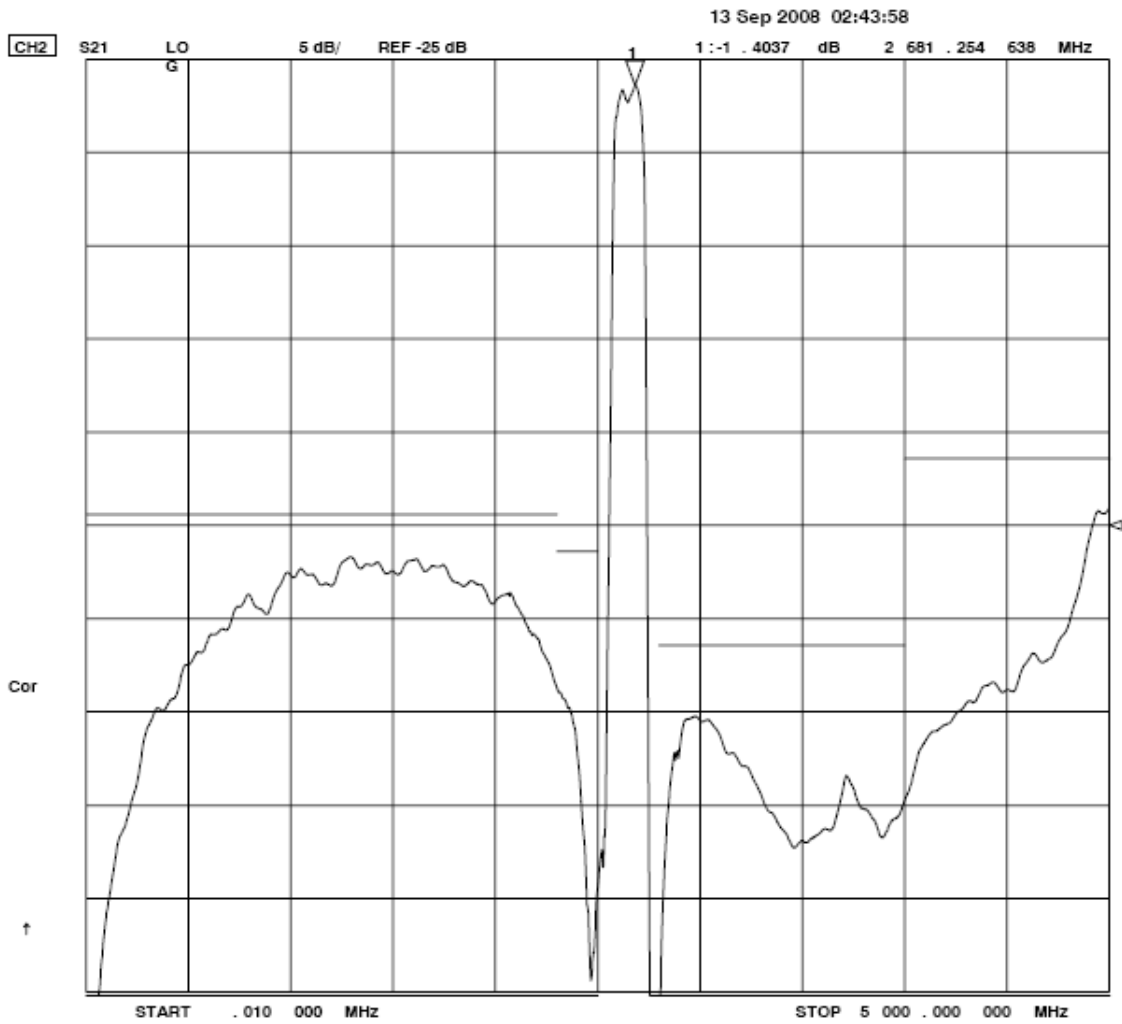

# Passband Filter Response

3 Sep 2008 14:02:47

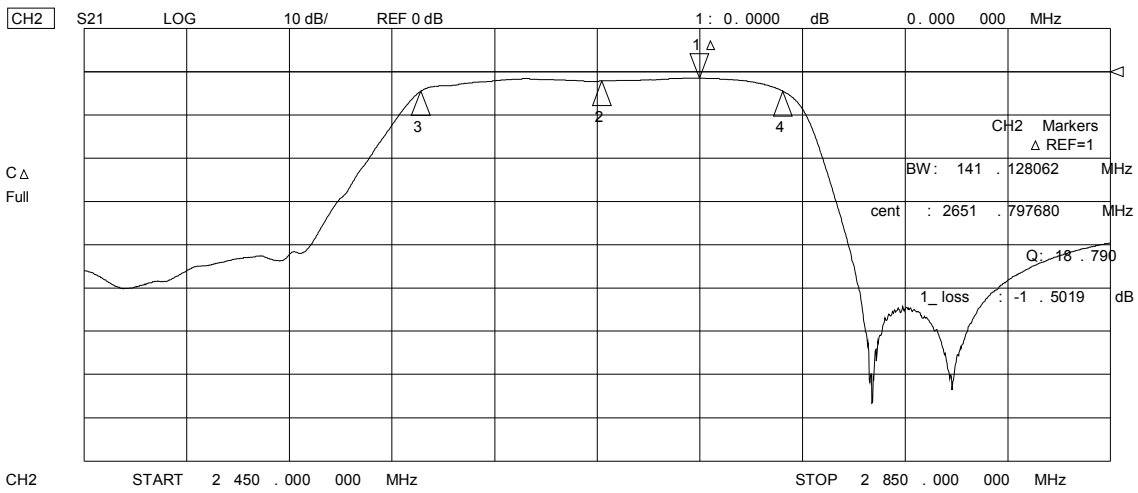
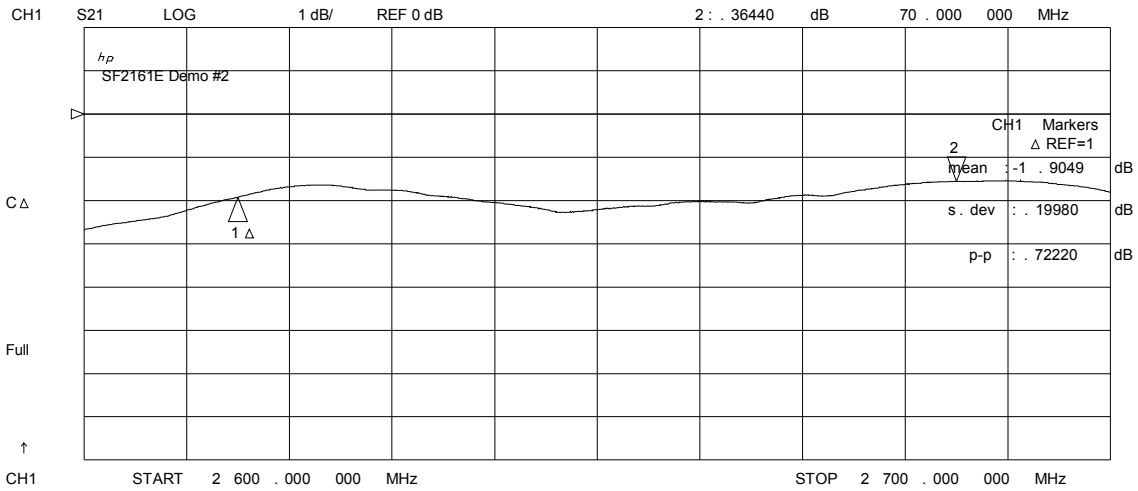

# SM3030-6 Case

## 6-Terminal Ceramic Surface-Mount Case 3.0 X 3.0 mm Nominal Footprint



PCB Footprint Top View

### Case and PCB Footprint Dimensions

Dimension	mm			Inches		
	Min	Nom	Max	Min	Nom	Max
A	2.87	3.00	3.13	0.113	0.118	0.123
B	2.87	3.00	3.13	0.113	0.118	0.123
C	1.12	1.25	1.38	0.044	0.049	0.054
D	0.77	0.90	1.03	0.030	0.035	0.040
E	2.67	2.80	2.93	0.105	0.110	0.115
F	1.47	1.60	1.73	0.058	0.063	0.068
G	0.72	0.85	0.98	0.028	0.033	0.038
H	1.37	1.50	1.63	0.054	0.059	0.064
I	0.47	0.60	0.73	0.019	0.024	0.029
J	1.17	1.30	1.43	0.046	0.051	0.056
K		3.20			0.126	
L		1.70			0.067	
M		1.05			0.041	
N		0.81			0.032	
O		0.38			0.015	

### Case Materials

Materials	
Solder Pad Plating	0.3 to 1.0 $\mu\text{m}$ Gold over 1.27 to 8.89 $\mu\text{m}$ Nickel
Lid Plating	2.0 to 3.0 $\mu\text{m}$ Nickel
Body	$\text{Al}_2\text{O}_3$ Ceramic

Top View

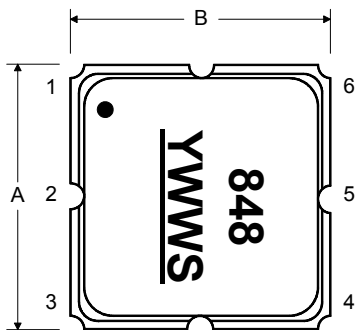

Bottom View

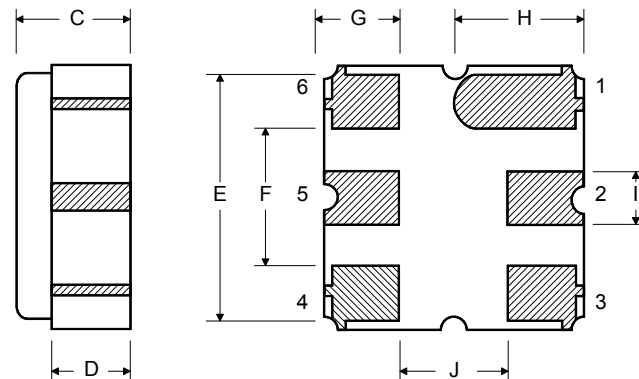

## Tape and Reel Specifications

Tape and Reel Standard per ANSI/EIA481

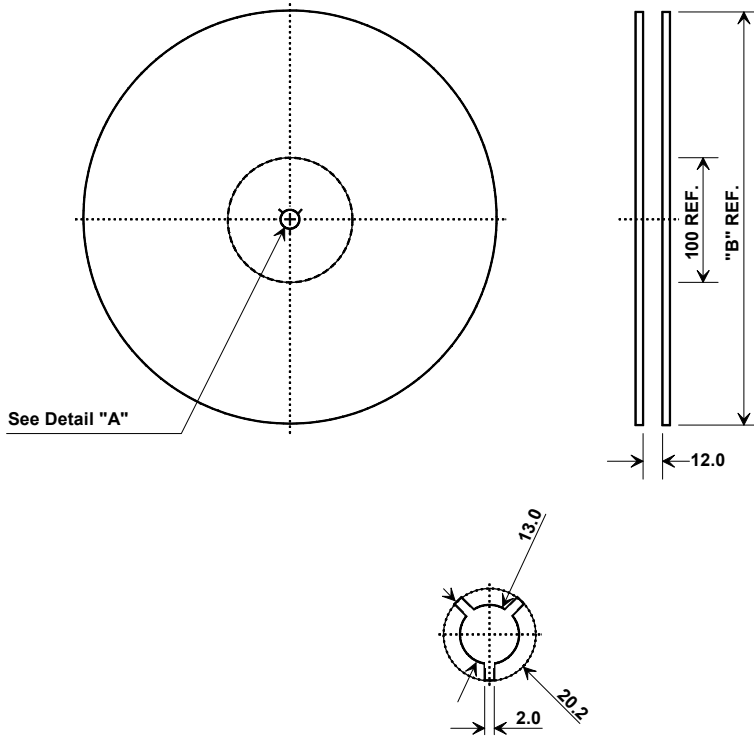

"B"		Quantity Per Reel
Inches	millimeters	
7	178	500
13	330	3000

### COMPONENT ORIENTATION and DIMENSIONS

Carrier Tape Dimensions	
Ao	3.35 mm
Bo	3.35 mm
Ko	1.40 mm
Pitch	8.0 mm
W	12.0 mm

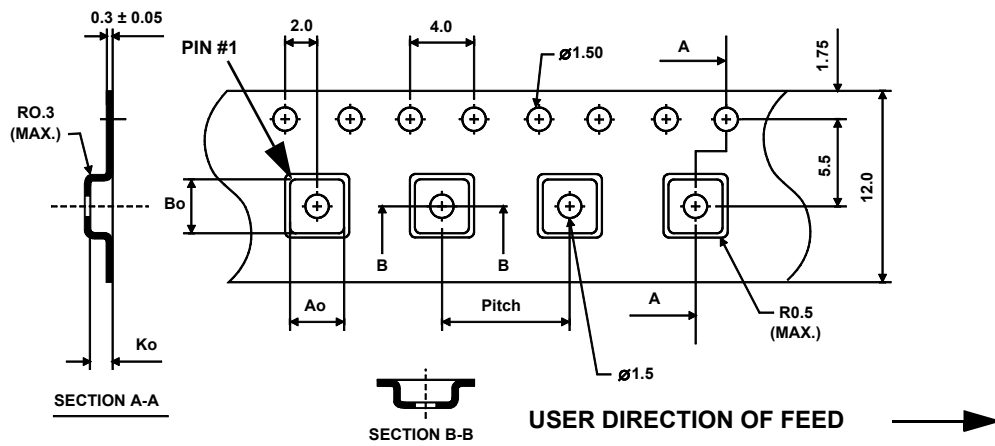

## Recommended Reflow Profile

1. Preheating shall be fixed at 150~180° for 60~90 seconds.
2. Ascending time to preheating temperature 150° shall be 30 seconds min.
3. Heating shall be fixed at 220°C for 50~80 seconds and at 260°C peak (10 seconds.)
4. Time: 5 times maximum

