

SF2510LA

**1582.47 MHz
SAW Filter**



SM1109-5

MAXIMUM RATING:

- Maximum Input Power Level: 15 dBm (In passband)
- DC Voltage: +/-5 V
- Operating Temperature Range: -40 °C to +85 °C
- Storage Temperature Range: -40 °C to +100 °C
- Moisture Sensitivity Level: Level 1 (MSL 1)
- ESD: 50 V(MM), 100 V(HBM)
- AEC-Q200 Qualified

ELECTRICAL CHARACTERISTICS:

Terminating source impedance: $Z_s = 50 \Omega$ (Single-ended)

Terminating load impedance: $Z_L = 50 \Omega$ (Single-ended)

Item		Unit	Min.	Typ.	Max.
Center Frequency	Fc	MHz	-	1582.47	-
Insertion Loss	1574.42 ~ 1576.42 MHz	dB(*1)	-	1.2	1.7
	1597.55 ~ 1605.89 MHz	dB(*1)	-	1.8	2.5
	1559.05 ~ 1563.14 MHz	dB(*1)	-	1.7	3.0
Amplitude Ripple	1574.42 ~ 1576.42 MHz	dB	-	0.1	0.8
	1597.55 ~ 1605.89 MHz	dB	-	0.55	1.4
	1559.05 ~ 1563.14 MHz	dB	-	0.2	1.8
Group Delay Ripple	1574.42 ~ 1576.42 MHz	nsec	-	1.0	6.0
	1597.55 ~ 1605.89 MHz	nsec	-	4.0	12.5
	1559.05 ~ 1563.14 MHz	nsec	-	5.0	20.0
VSWR	1574.42 ~ 1576.42 MHz	-	-	1.5	2.1
	1597.55 ~ 1605.89 MHz	-	-	1.4	2.0
	1559.05 ~ 1563.14 MHz	-	-	1.5	2.0
Attenuation (Reference level from 0 dB)					



CAUTION: Electrostatic Sensitive Device. Observe precautions for handling.

NOTES:

1. The design, manufacturing process, and specifications of this device are subject to change.
2. US or International patents may apply.
3. RoHS compliant from the first date of manufacture.

699 ~ 716 MHz	dB	43	47	-
777 ~ 787 MHz	dB	45	46.5	-
814 ~ 849 MHz	dB	45	46.5	-
880 ~ 915 MHz	dB	45	46.5	-
1427.9 ~ 1446.9 MHz	dB	45	53	-
1447.9 ~ 1462.9 MHz	dB	45	54	-
1710 ~ 1785 MHz	dB	47	54	-
1850 ~ 1915 MHz	dB	47	54	-
1920 ~ 1980 MHz	dB	47	54	-
2400 ~ 2500 MHz	dB	45	50	-
2500 ~ 2570 MHz	dB	45	50	-

(*1) Specification of insertion loss excludes loss that comes from the test board.

MEASUREMENT CIRCUIT:

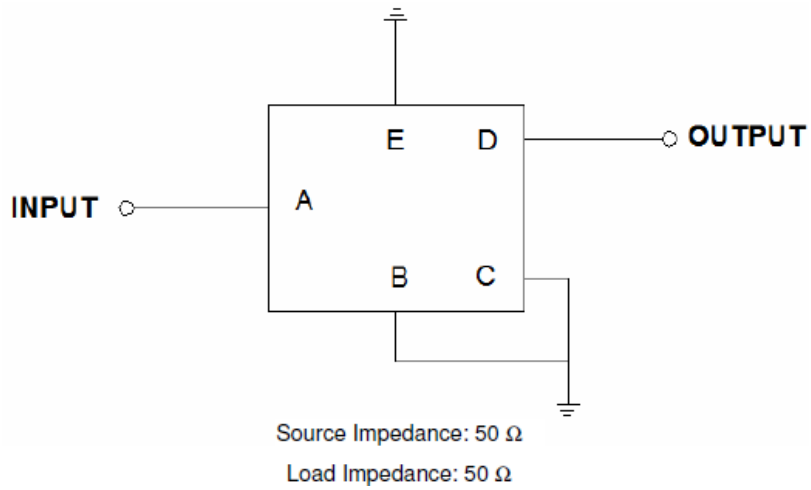

FREQUENCY CHARACTERISTICS:

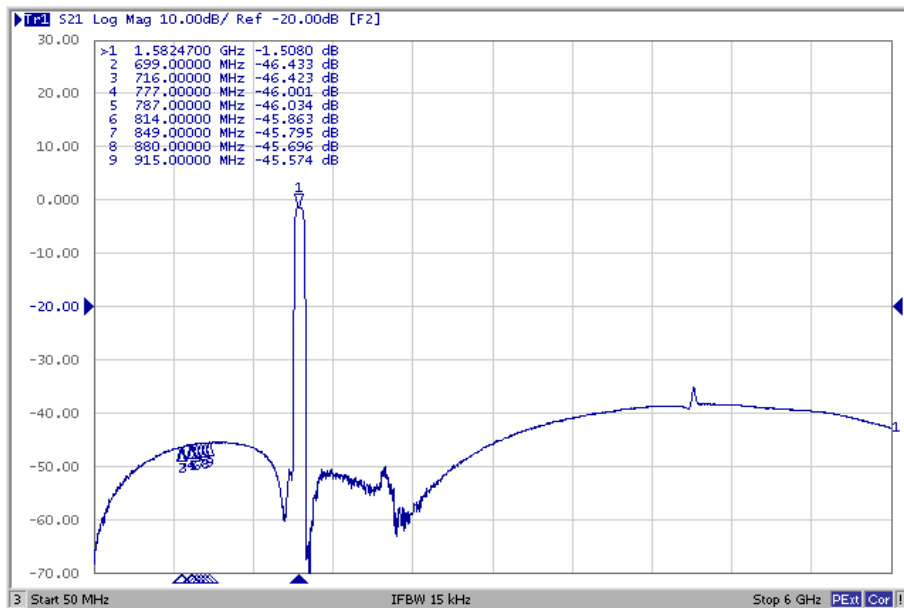
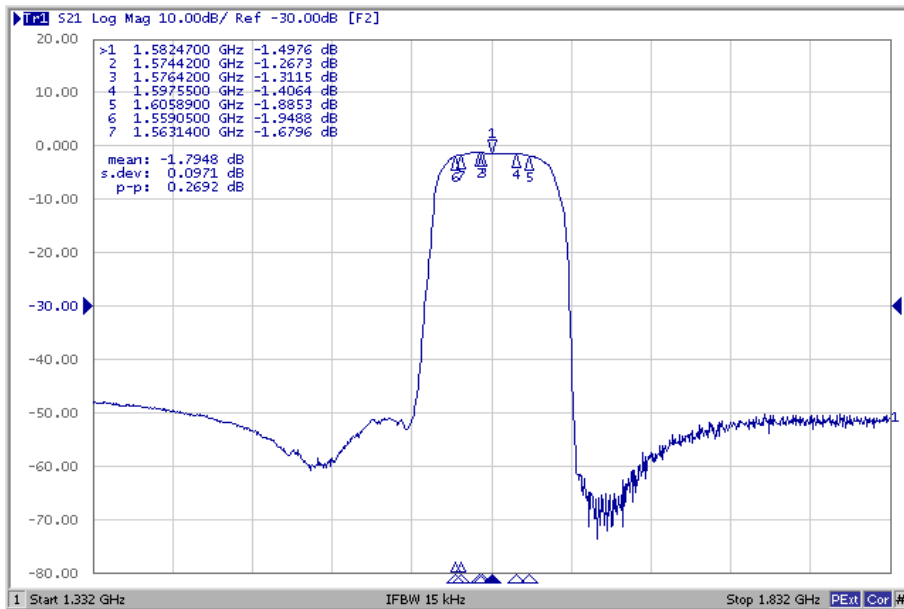
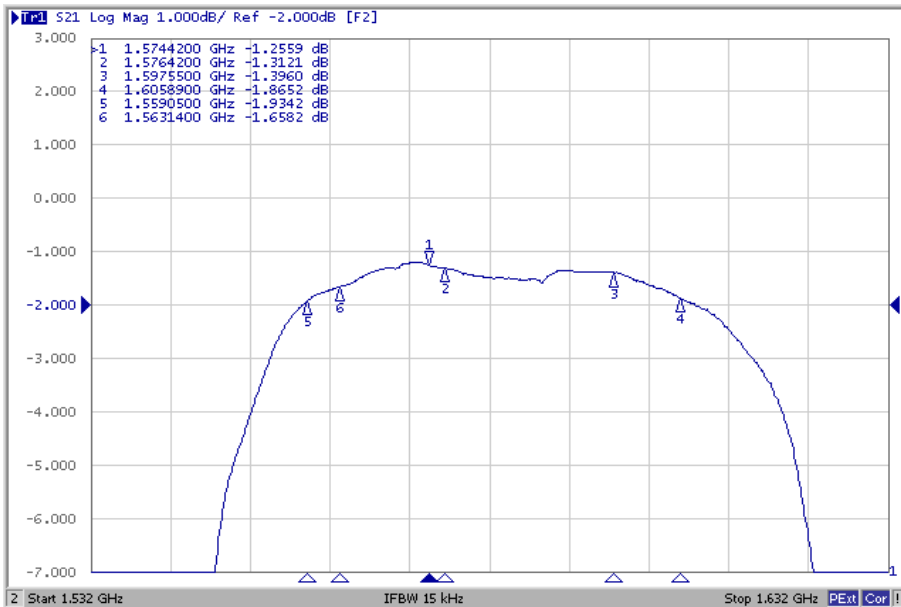

Group Delay Ripple

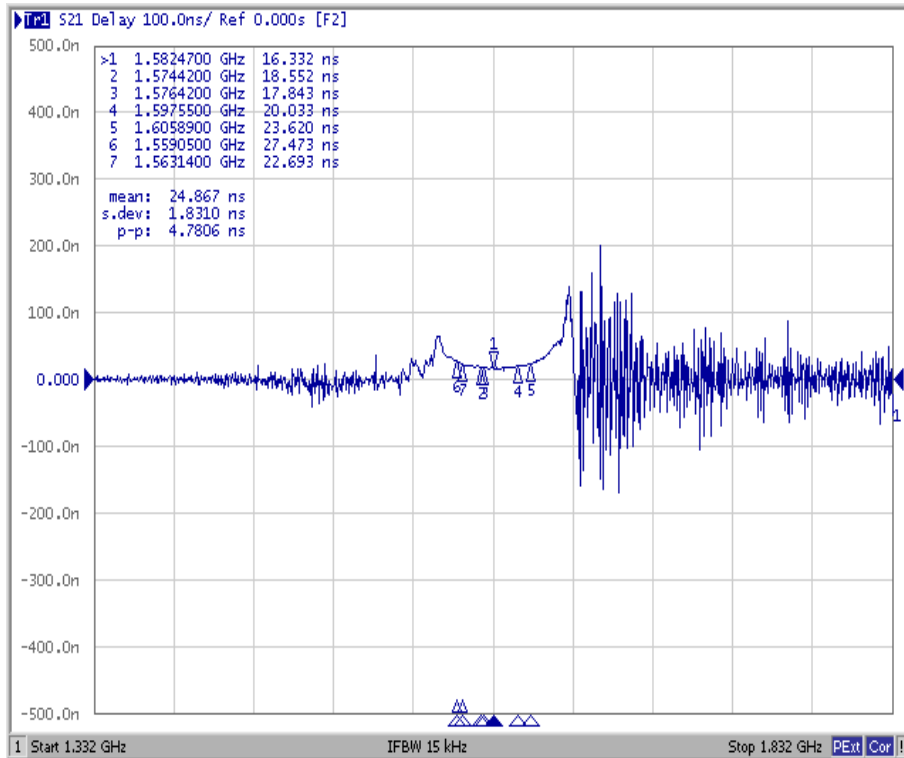

Reflection Functions:

VSWR

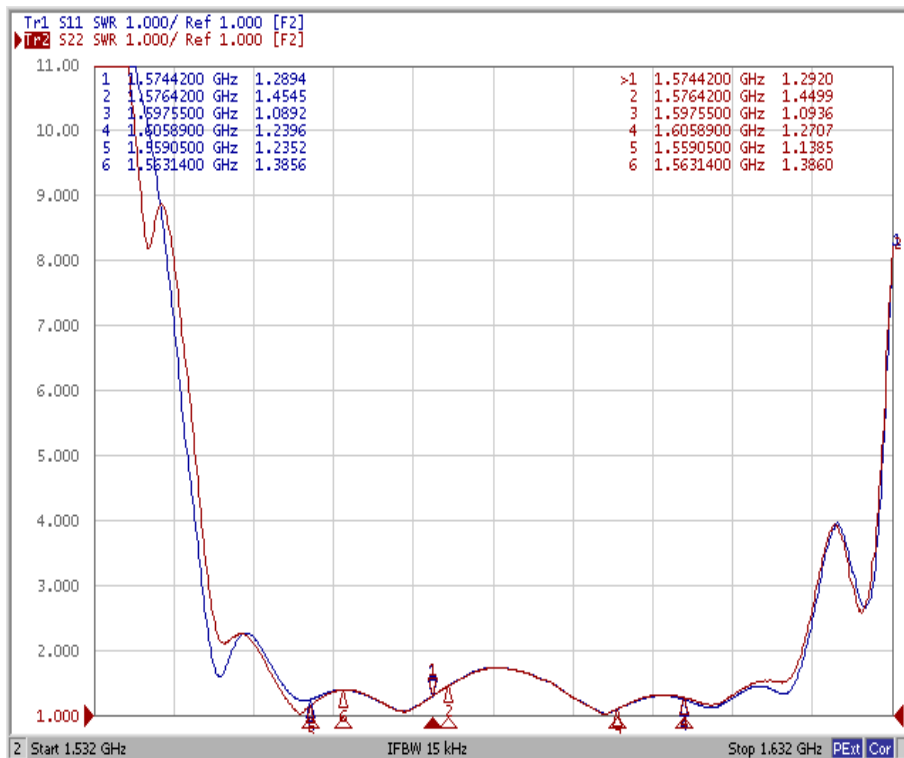

Smith Chart

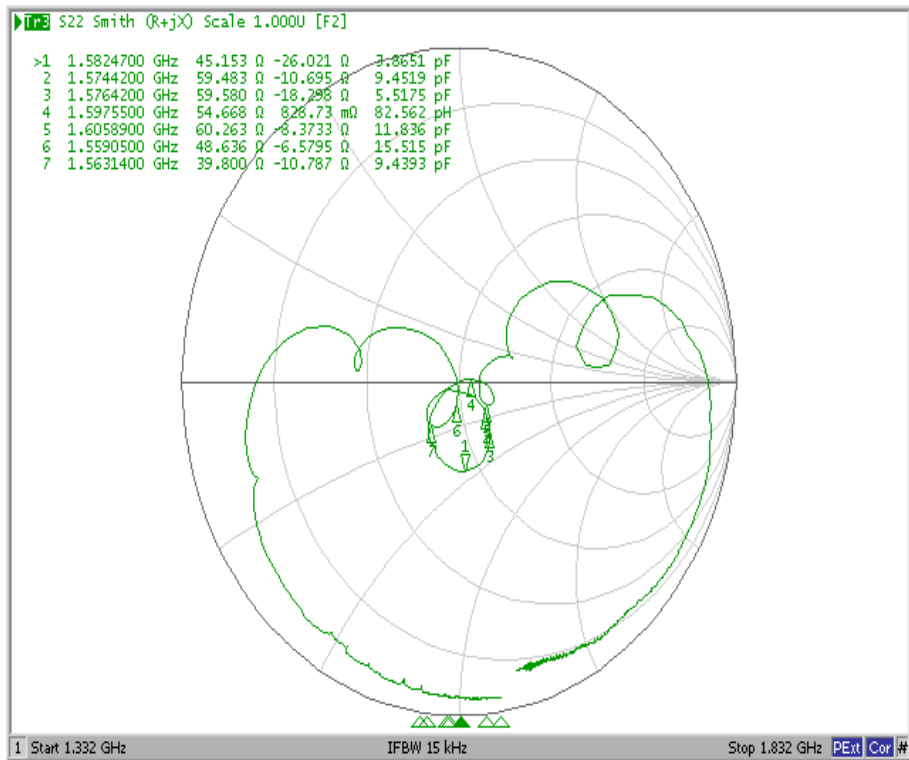
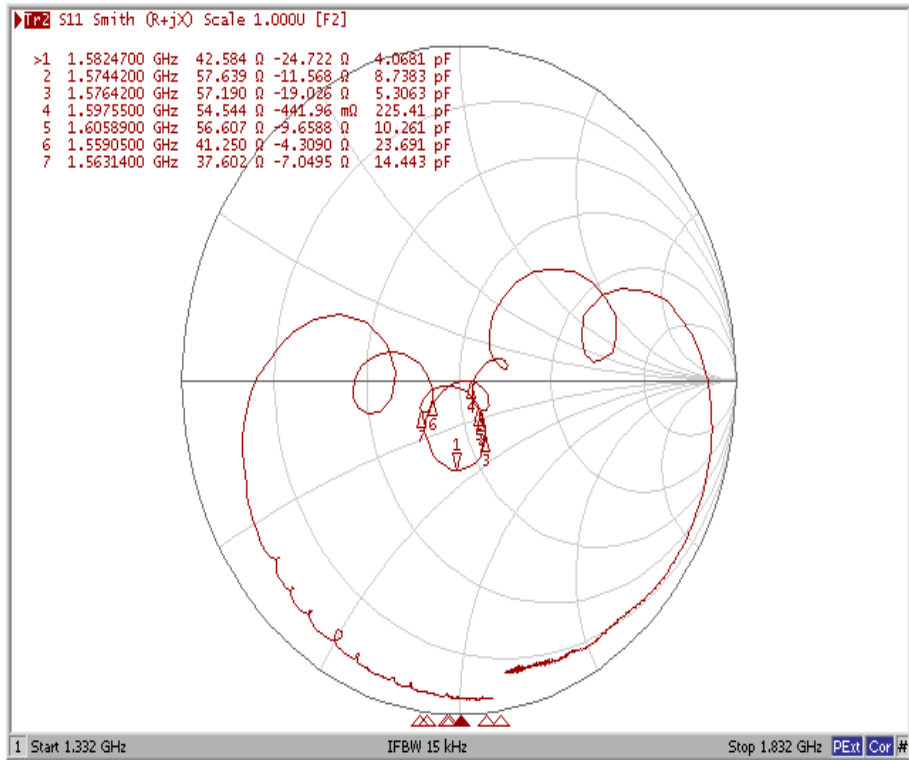

PCB FOOTPRINT:

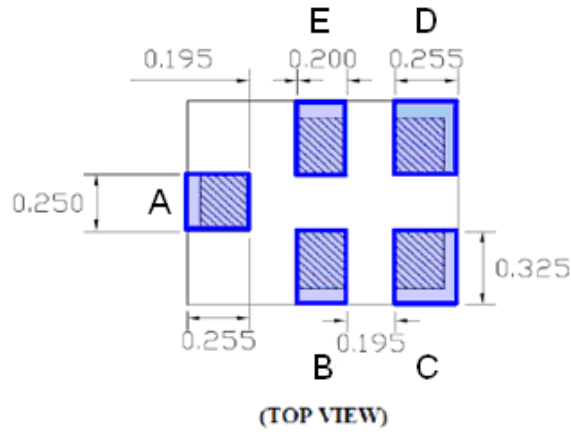

OUTLINE DRAWING:

Device size: 1.1typ. x 0.9typ. x 0.5max.

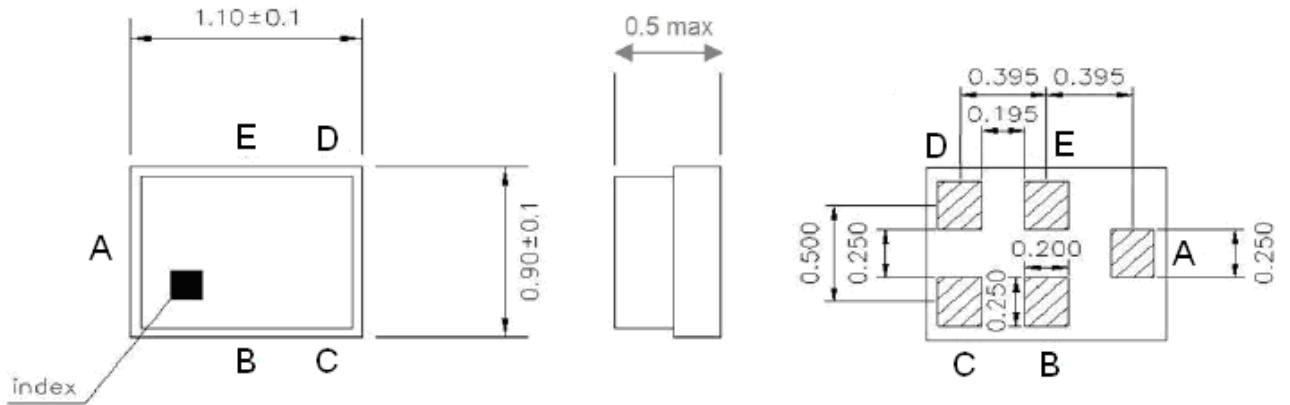

All tolerances are +/-0.1 mm unless otherwise specified.
Unit: mm

Pin Configuration

Pin No.	Symbol	Function
A	IN	Unbalanced input
B	GND	Ground
C	GND	Ground
D	OUT	Unbalanced output
E	GND	Ground

Top View (Sample Production):

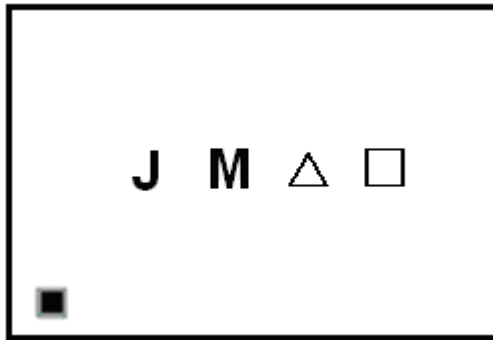

Top View (Mass Production):

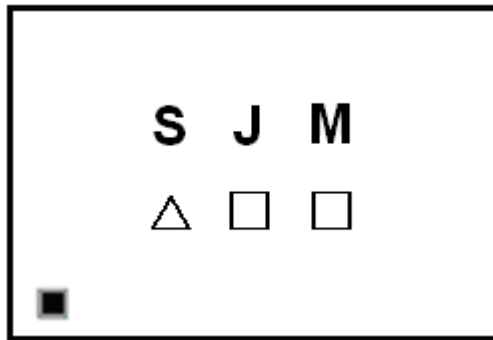

△ : Date Code

□ : Lot No. (Indicated by 0~9 or A to Z and a to z, except I, O, i, o and l)

Date Code:

Year	Jan	Feb	Mar	Apr	May	Jun	Jul	Aug	Sep	Oct	Nov	Dec
2020	n	p	q	r	s	t	u	v	w	x	y	z
2021	A	B	C	D	E	F	G	H	J	K	L	M
2022	N	P	Q	R	S	T	U	V	W	X	Y	Z
2023	a	b	c	d	e	f	g	h	j	k	l	m

PACKING:
1. REEL DIMENSION

Reel Count:
7" = 5000

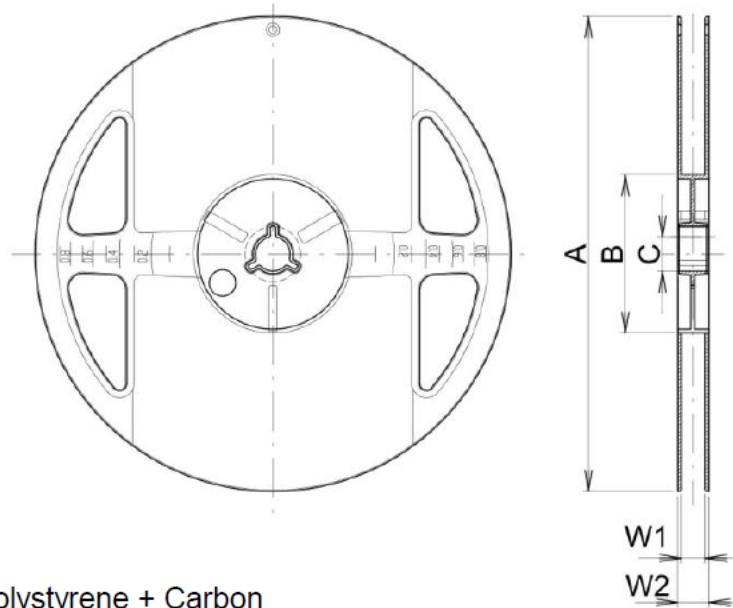

Material : Polystyrene + Carbon
Color : Black
Surface resistance (reference value) : $10^9 \Omega/\text{sq}$ max.

Unit : mm				
A	B	C	W1	W2
180.0 $+0.0/-1.5$	60.0 $+1.0/-0.0$	13.0 ± 0.2	9.0 $+1.0/-0.0$	11.4 ± 1.0

2. TAPE DIMENSION

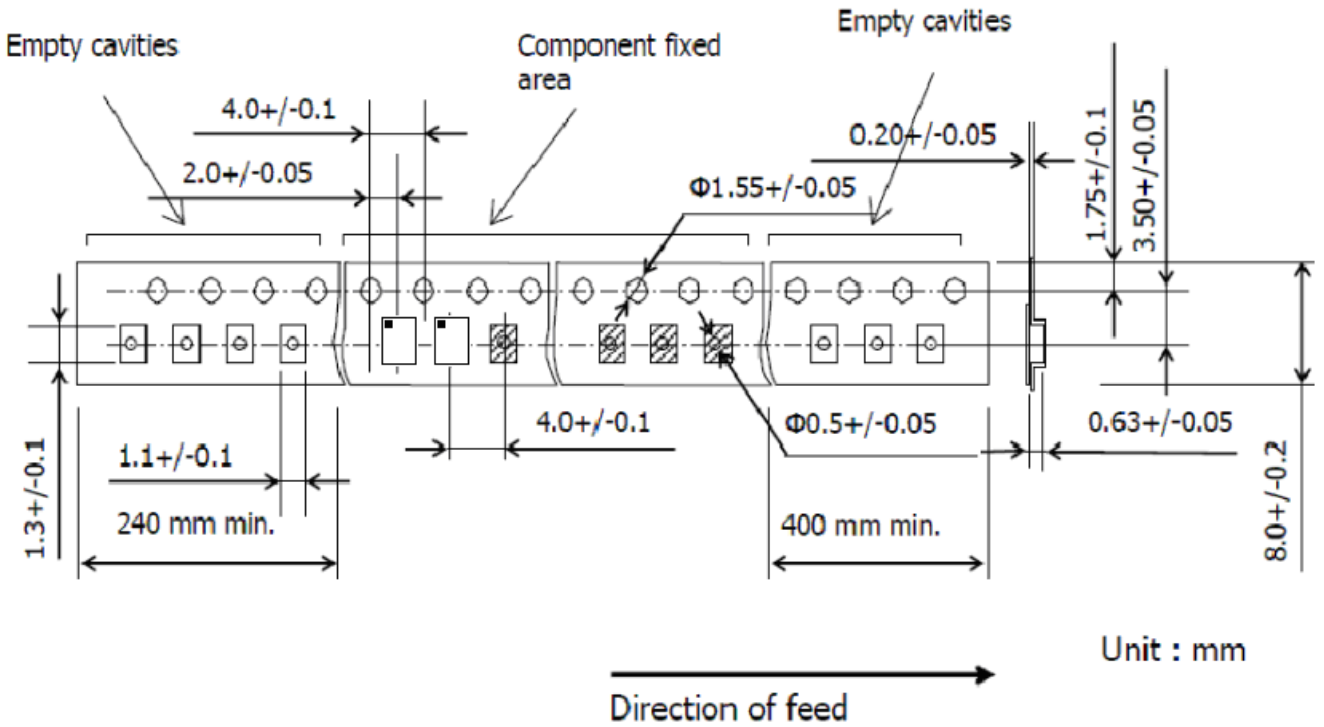

RECOMMENDED REFLOW PROFILE:

1. Preheating shall be fixed at 150~180°C for 60~90 seconds.
2. Ascending time to preheating temperature 150°C shall be 30 seconds min.
3. Heating shall be fixed at 220°C for 50~80 seconds and at 260°C+0/-5°C peak (20~40sec).
4. Time: 2 times.

