

SF2535N

**1950/2140 MHz
Filter Duplexer**

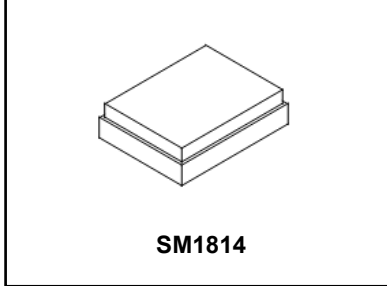

MAXIMUM RATING:

- Operating temperature range: -40 °C to +85 °C
- Storage temperature range: -55 °C to +125 °C
- Input power : 29dBm (Ta=+50deg C,10kh,CW)
- Maximum DC Voltage: +/-3 V
- Moisture Sensitivity Level: Level 3
- ESD 50V(MM) 100V(HBM)

ELECTRICAL CHARACTERISTICS:

Terminating impedance (Tx Port): 50 Ω (Single-ended)
 Terminating impedance (Rx Port): 50 Ω (Single-ended)
 Terminating impedance (Ant Port): 50//2.7nH Ω (Single-ended)

Tx to ANT (f_{T0}=1950 MHz)

Parameters Description		Unit	Min	Typ	Max	Remarks
Insertion Loss	1920.48~1979.52MHz	dB(*1)	-	1.8	2.2	
Amplitude ripple	1920.48~1979.52MHz	dB	-	0.6	1.2	
VSWR	Tx	-	-	1.8	2.2	
	ANT	-	-	1.5	2.0	
Attenuation:						
1559~1563 MHz		dB	38	41	-	
1565~1606 MHz		dB	38	41	-	
1805~1880 MHz		dB	10	25	-	
2110~2170 MHz		dB	42	50	-	
2400~2500 MHz		dB	33	37	-	
3840~3960 MHz		dB	25	29	-	



CAUTION: Electrostatic Sensitive Device. Observe precautions for handling.

NOTES:

1. The design, manufacturing process, and specifications of this device are subject to change.
2. US or International patents may apply.
3. RoHS compliant from the first date of manufacture.

ANT to Rx (f_{T0}=2140 MHz)

Parameters Description		Unit	Min	Typ	Max	Remarks
Insertion Loss	2110.48~2169.52MHz	dB(*1)	-	1.8	2.2	
Amplitude ripple	2110.48~2169.52MHz	dB	-	0.6	1.2	
VSWR	ANT	2110.48~2169.52MHz	-	1.6	2.0	
	Rx		-	1.6	2.1	
Attenuation:						
190 MHz		dB	50	81	-	
1730~1790 MHz		dB	40	46	-	
1920~1980 MHz		dB	45	49	-	
1980~2015 MHz		dB	15	49	-	
2015~2075 MHz		dB	18	28	-	
2400~2500 MHz		dB	35	40		
4030~4150 MHz		dB	35	44		
5950~6130 MHz		dB	33	41		

Tx to Rx

Isolation	1920.48~1979.52 MHz	dB	53	56	-	
			53	57	-	
	2110.48~2169.52 MHz	dB	49	51	-	
			51	55	-	

(*1) Specification of insertion loss excludes loss that comes from the test board.

FREQUENCY CHARACTERISTICS:

Tx to Ant

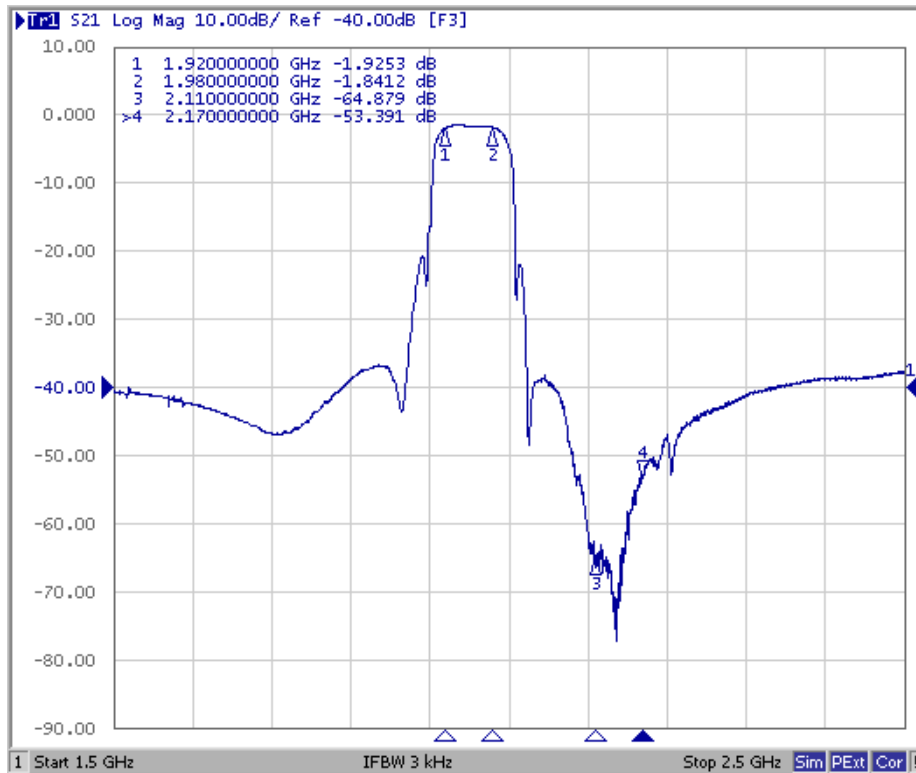

Ant to Rx

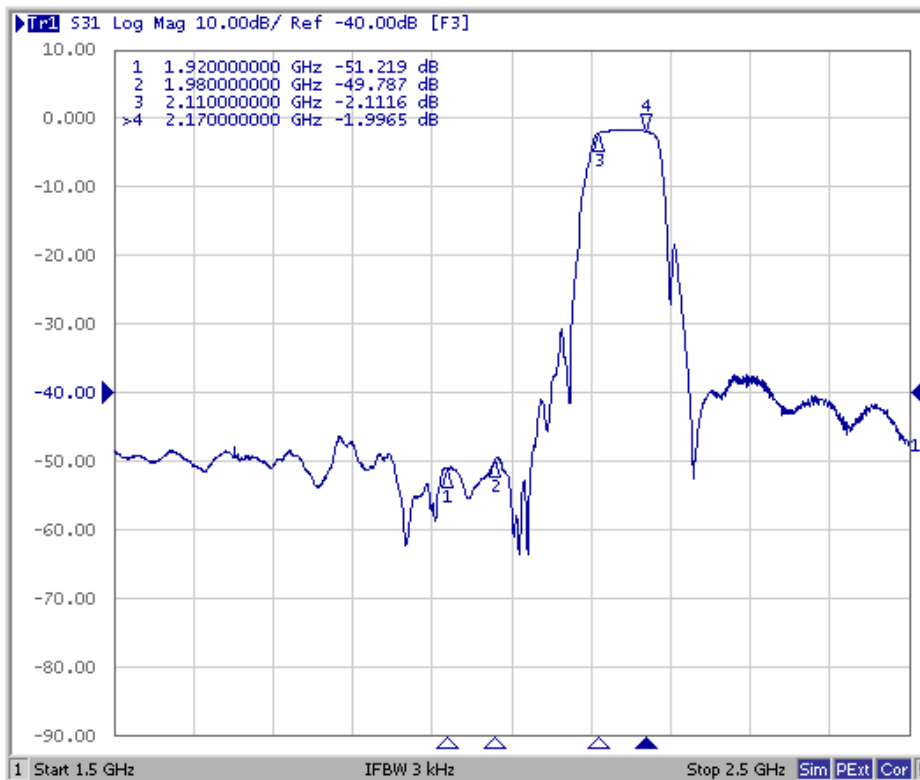

These data **exclude** loss that comes from the test board.

Tx to Ant ,Ant to Rx

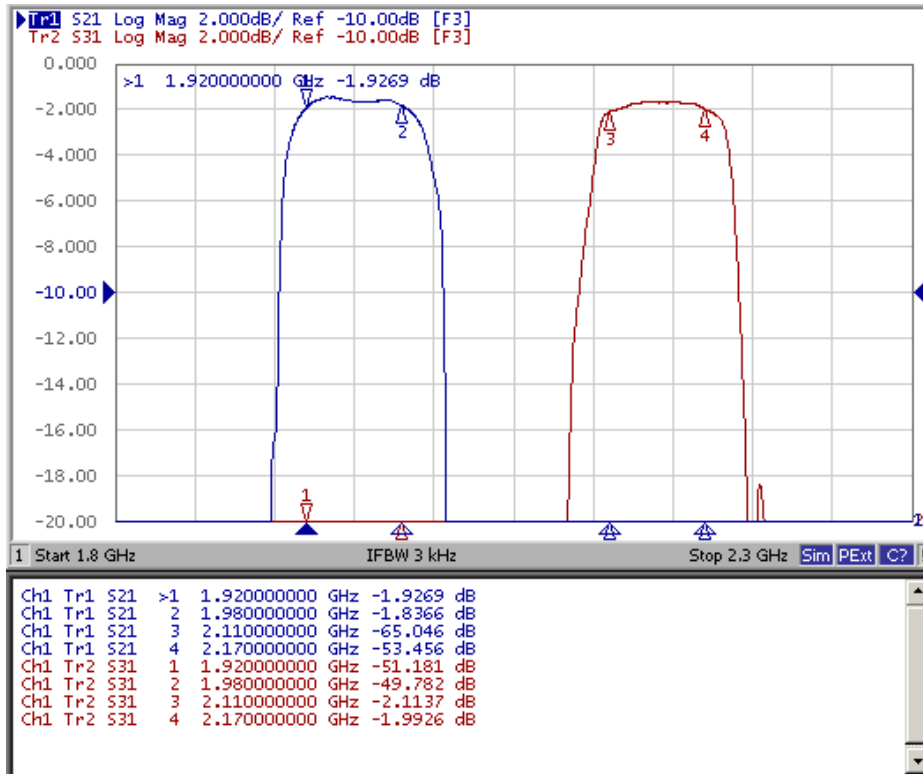

Tx to Rx Isolation

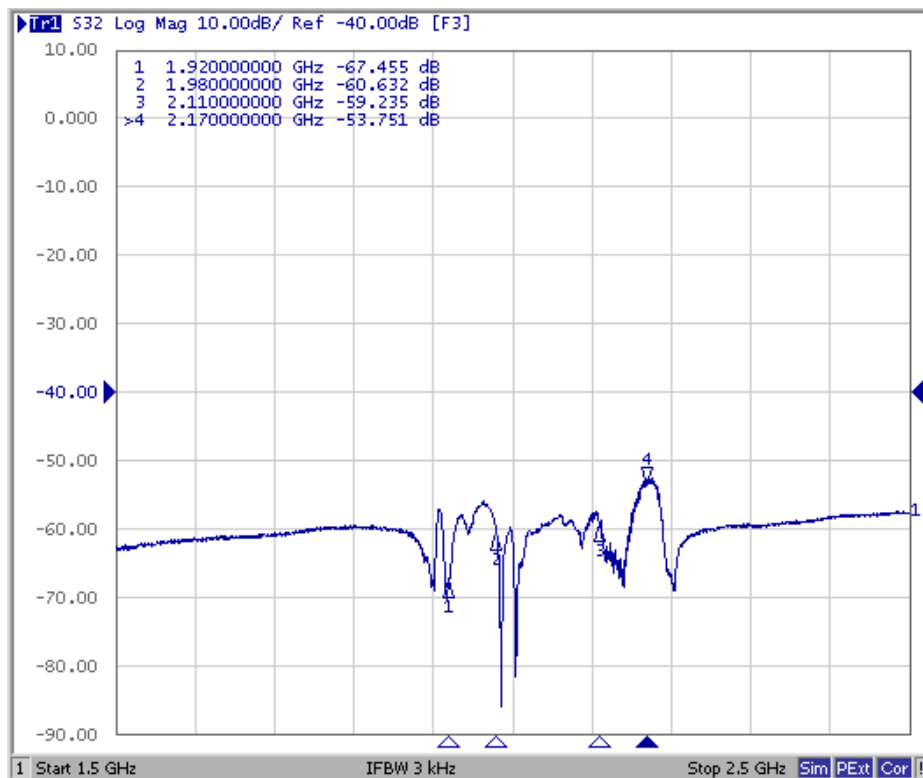

These data **exclude** loss that comes from the test board.

Tx Port

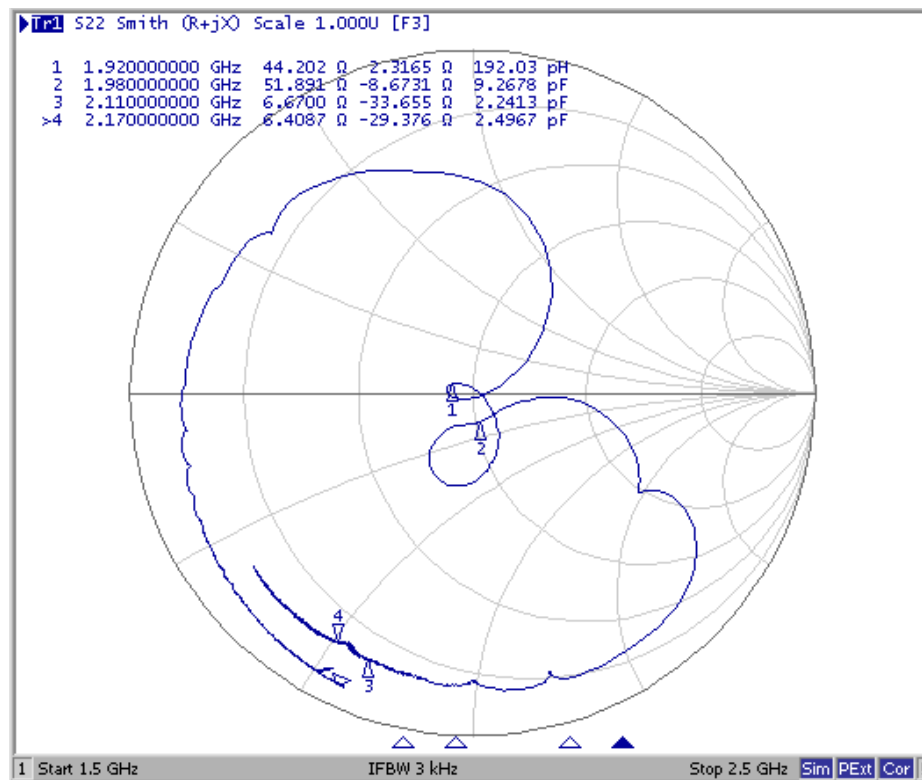
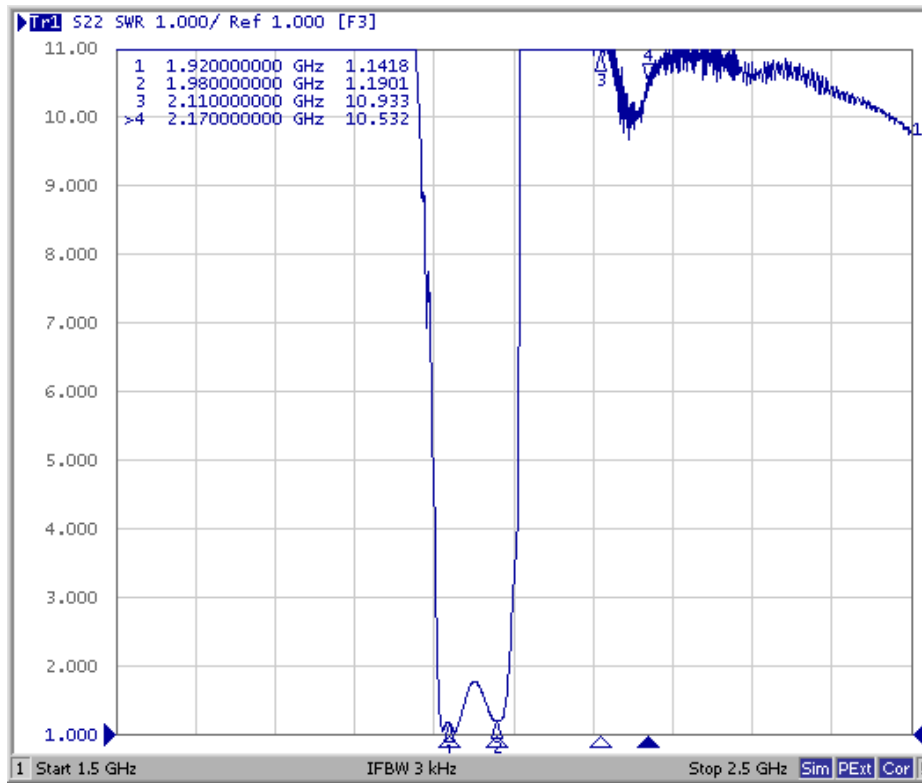

Rx Port

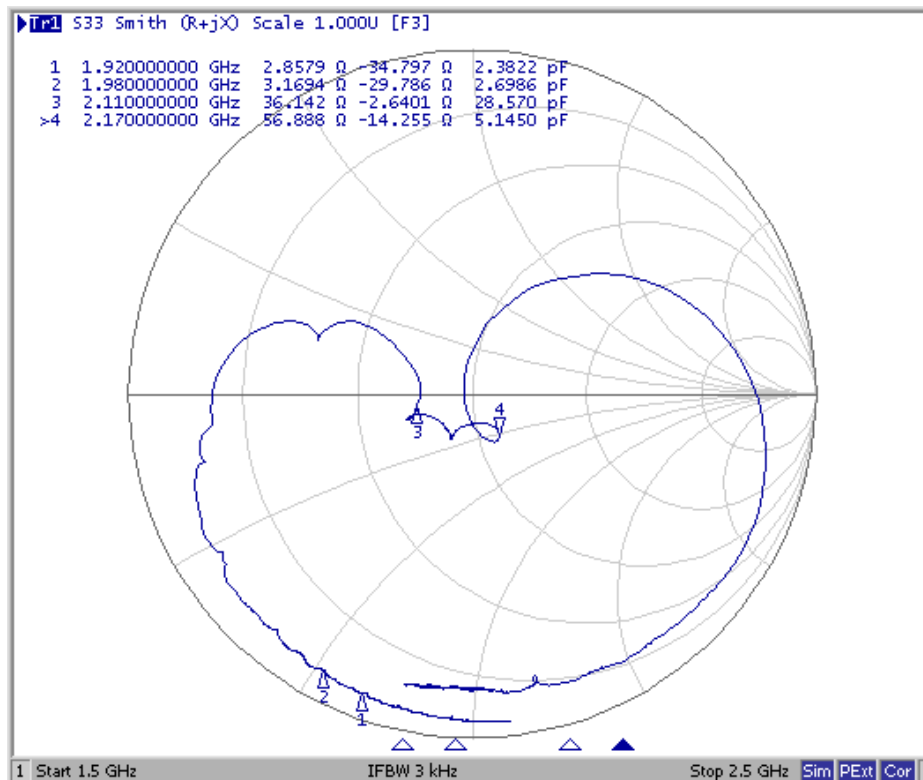
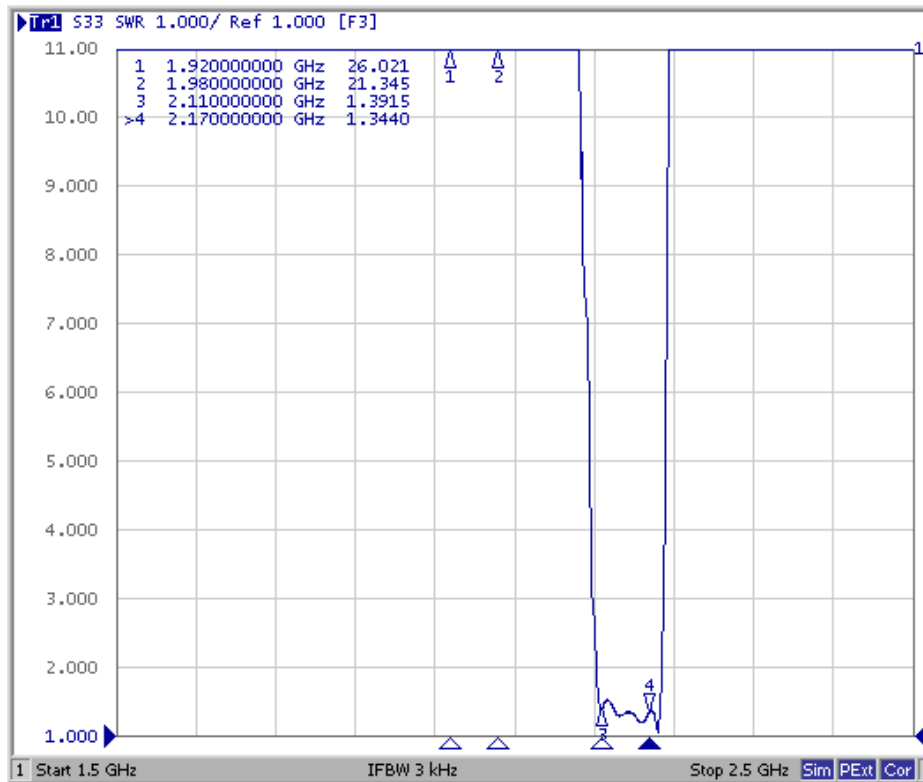

Ant Port

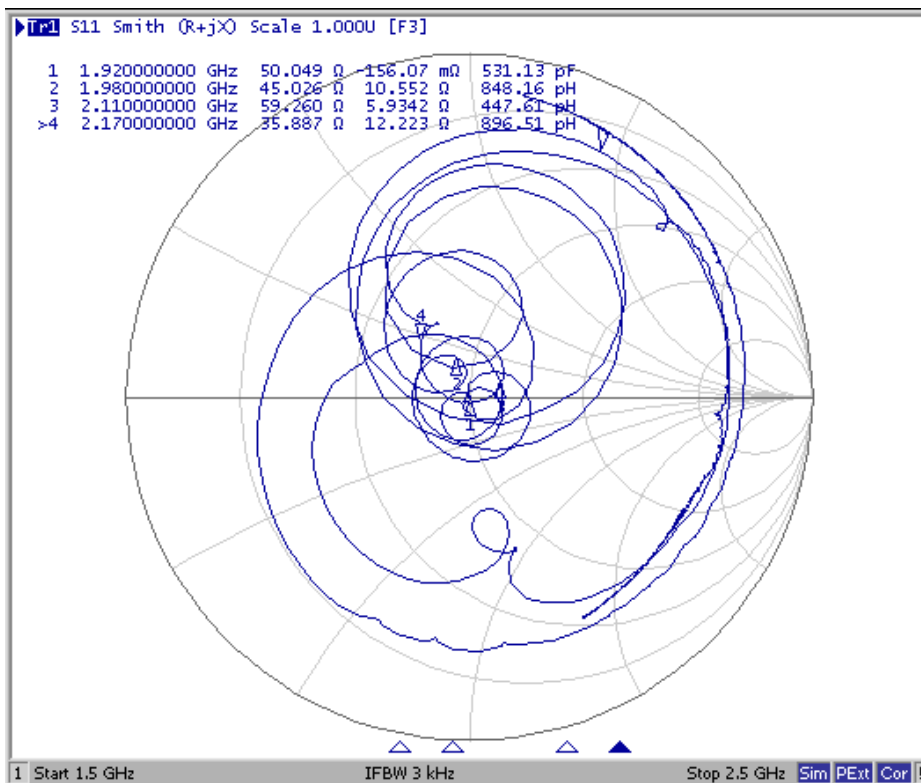
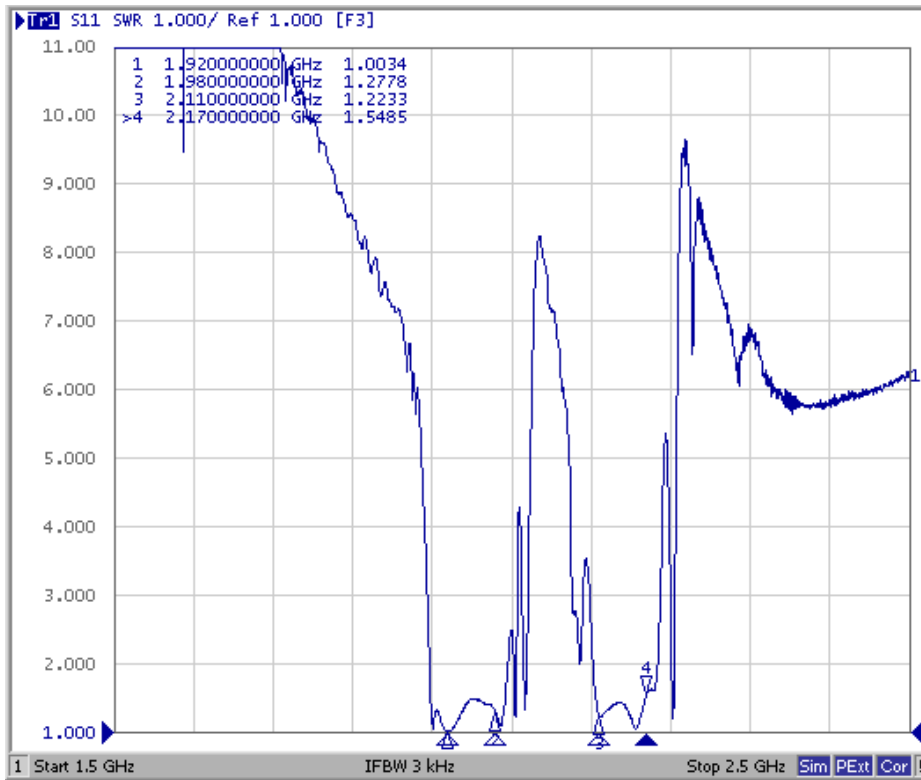

Tx to Ant (Wide span)

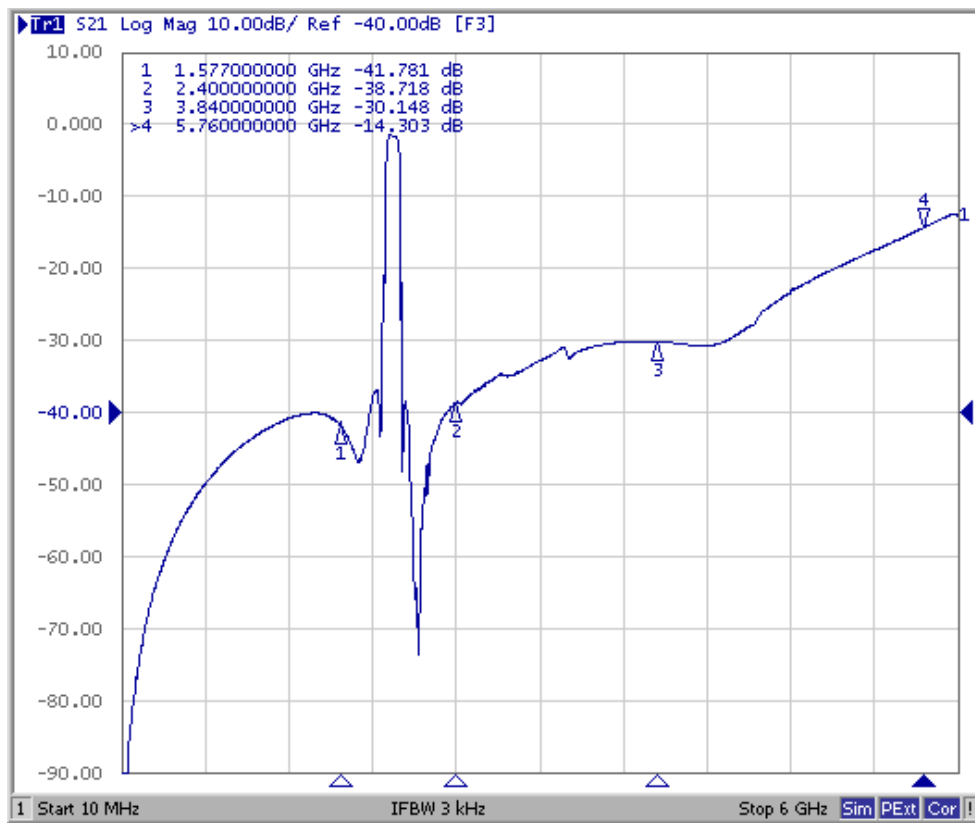

Ant to Rx (Wide span)

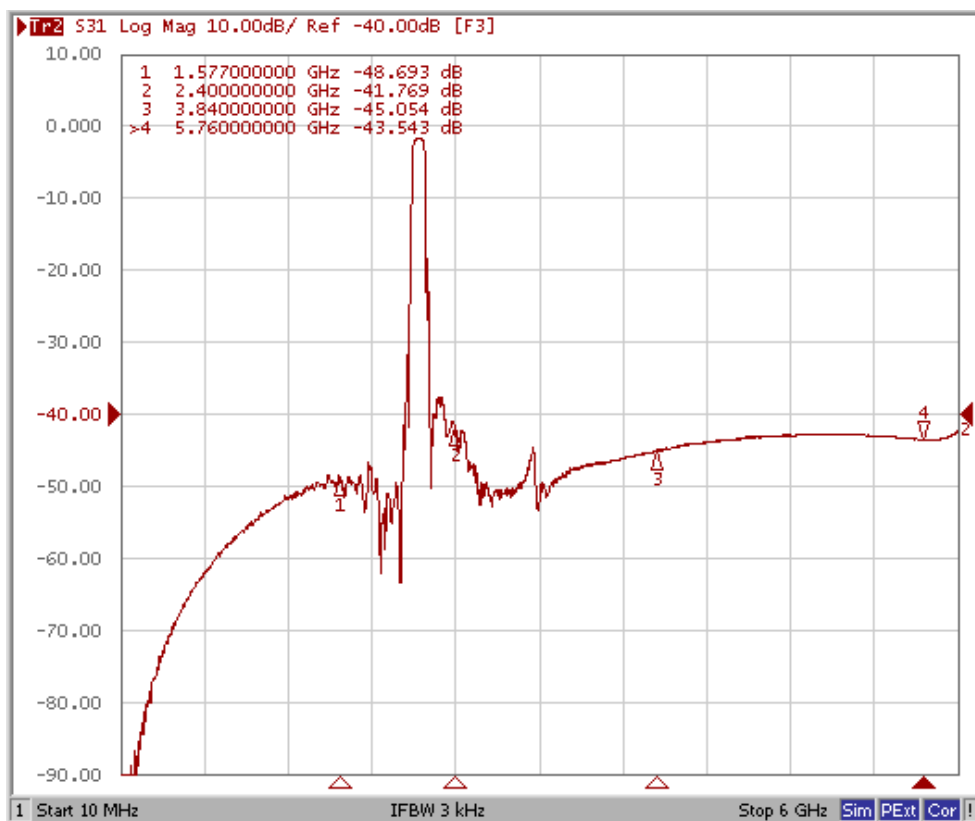

OUTLINE DRAWING:

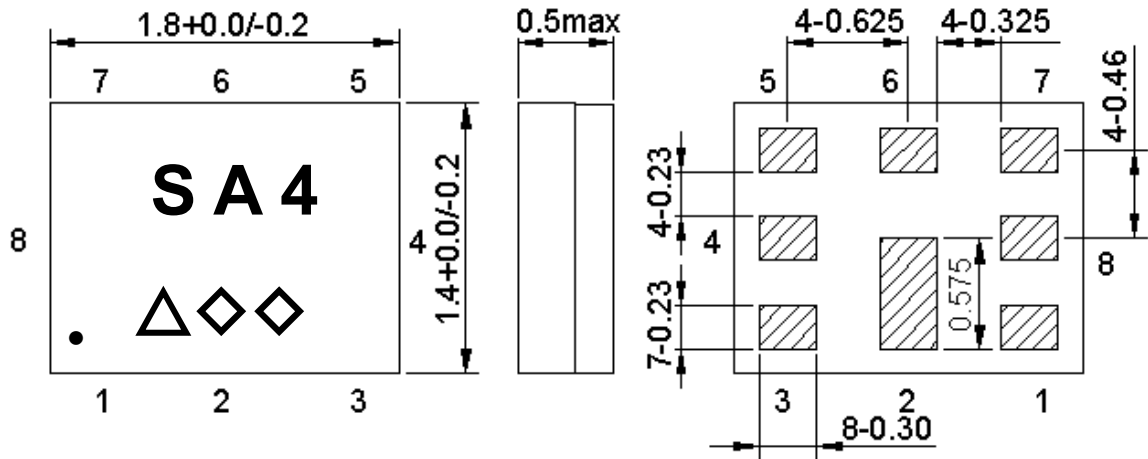

Not Specified Tolerance : +/-0.05 mm
 Coplanarity : 0.1 mm max.
 1 to 8 : Pin No.
 Unit : mm

Marking name : **SA4**

△: Date code(2016 May → s ,....., 2019 Dec→m.)

◇◇: Lot Code.

Product Date Code. Follow below table.

Year	Jan	Feb	Mar	Apr	May	Jun	Jul	Aug	Sep	Oct	Nov	Dec
2016	n	p	q	r	s	t	u	v	w	x	y	z
2017	A	B	C	D	E	F	G	H	J	K	L	M
2018	N	P	Q	R	S	T	U	V	W	X	Y	Z
2019	a	b	c	d	e	f	g	h	j	k	l	m
2020	n	p	q	r	s	t	u	v	w	x	y	z
2021	A	B	C	D	E	F	G	H	J	K	L	M

Pin Configuration:

Pin No.	Pin Name	Description
1	Rx	Receive Pin
2	GND	Ground Pin
3	Tx	Transmitter Pin
4	GND	Ground Pin
5	GND	Ground Pin
6	ANT	Antenna Pin
7	GND	Ground Pin
8	GND	Ground Pin

Evaluation Circuit

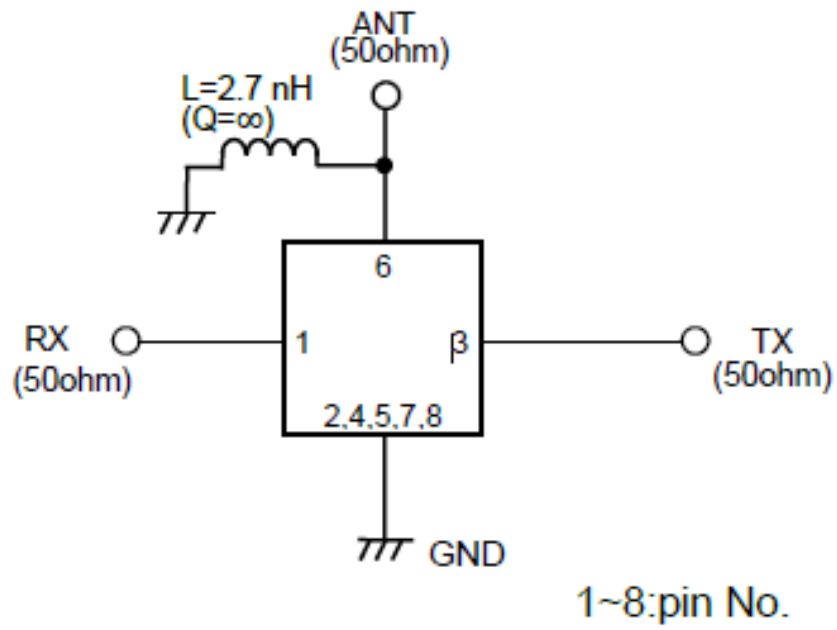

FOOTPRINT:

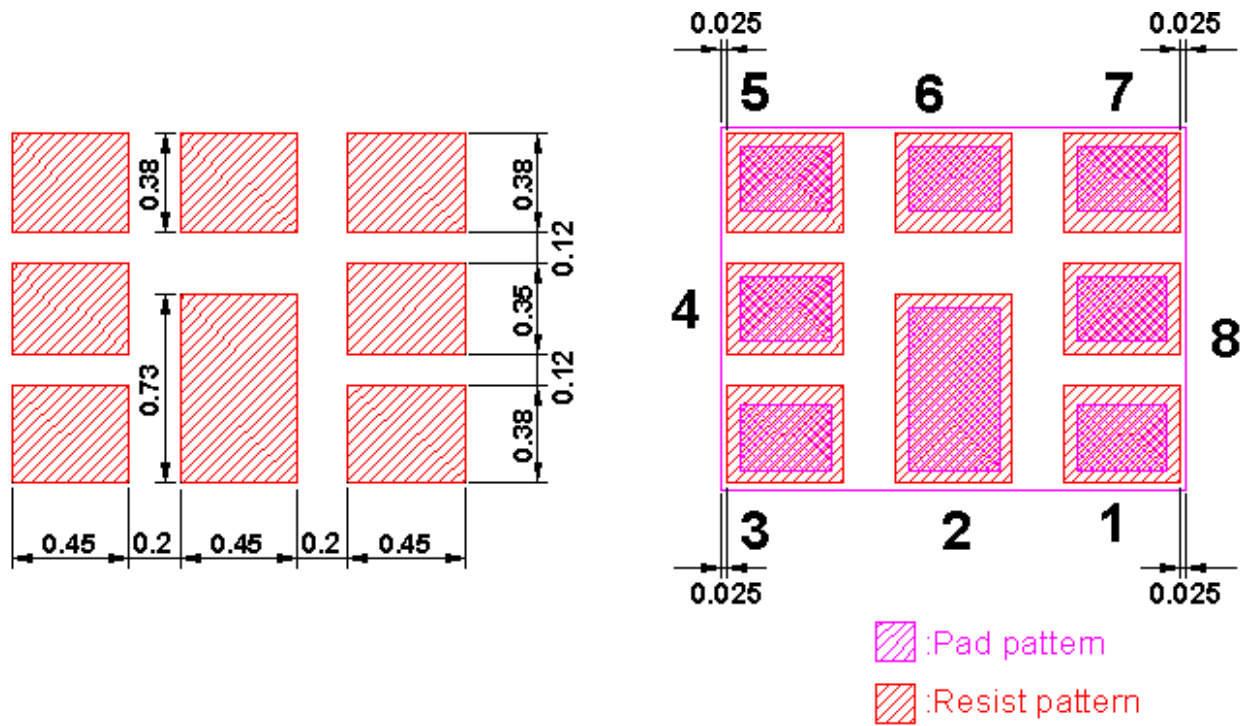

PACKING:
REEL DIMENSION

Reel Count:
7" = 3000
13" = 10,000

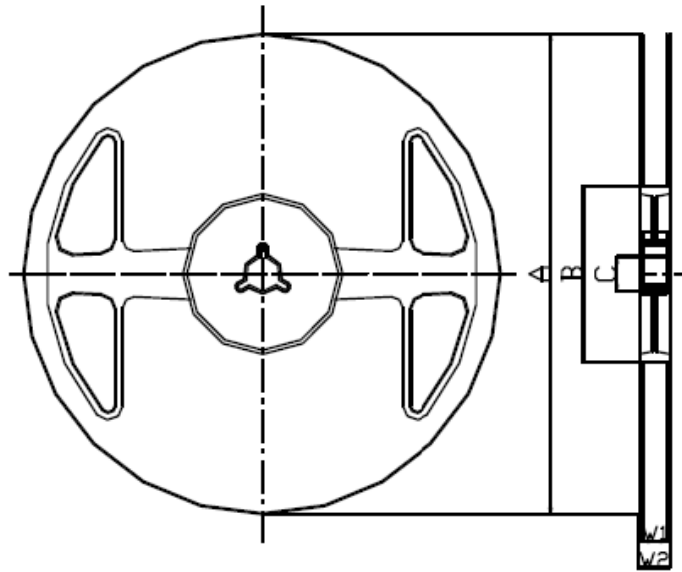

Materials of Reel

Material : Polystyrene + Carbon
 Characteristics : Conforms to EIAJ-ET-7200A
 Color : Black
 Surface resistance (reference value) : $10^9 \Omega/\text{sq}$ Max.

Unit : mm

Code	Quantity	A	B	C	W1	W2
Z	3,000 pcs	$\phi 180.0 +0.0/-1.5$	$\phi 66.0 +/-0.5$	$\phi 13.0 +/-0.2$	$9.0 +1.0/-0.0$	$11.4 +/-1.0$

TAPE DIMENSION

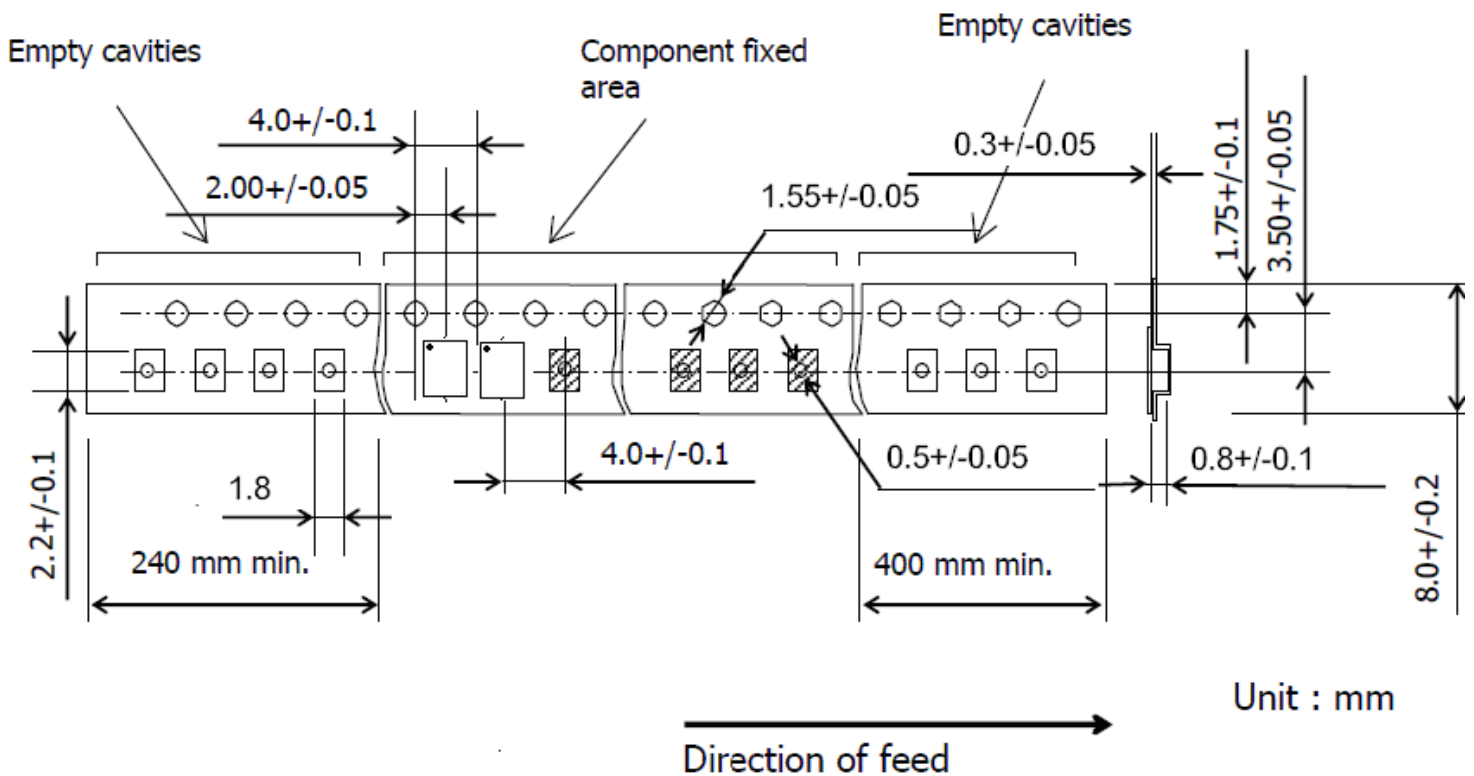

Unit : mm

RECOMMENDED REFLOW PROFILE :

1. Preheating shall be fixed at 150~180°C for 60~90 seconds.
2. Ascending time to preheating temperature 150°C shall be 30 seconds min.
3. Heating shall be fixed at 220°C for 50~80 seconds and at 245~260°C peak (min. 10sec).
4. Time : 3 times.

