

SM1814

MAXIMUM RATING:

- Operating temperature range: -40 °C to +85 °C
- Storage temperature range: -55 °C to +125 °C
- Input power : 29dBm (Ta=+50deg C,5khours,CW)
- Maximum DC Voltage: +/-3 V
- Moisture Sensitivity Level: Level 1
- ESD 50V(MM) 100V(HBM)
- AEC-Q200 Qualified

ELECTRICAL CHARACTERISTICS:

Terminating impedance (Tx Port): 50 Ω(Single-ended)

Terminating impedance (Rx Port): 50 Ω (Single-ended)

Terminating impedance (Ant Port): 50//3.2nH Ω (Single-ended)

Tx to ANT (f_{TO}=2535 MHz)

Parameters Description		Unit	Min	Typ	Max	Remarks
Insertion Loss	2500~2570MHz	dB(*1)	-	2.3	2.9	2500~2510MHz
		dB(*1)		1.7	2.7	2510~2570MHz
Ripple	2500~2570MHz	dB	-	1.2	2.3	
Ripple(any 5MHz)	2500~2570MHz	dB		0.5	1.0	
VSWR	ANT	-	-	1.6	2.4	
	Tx	-	-	1.8	2.5	
Attenuation:						
10~1565.42 MHz		dB	35	40	-	
832~862 MHz		dB	45	51	-	
1226~1250 MHz		dB	38	44	-	
1559~1563 MHz		dB	35	40	-	
1565.42~1573.374 MHz		dB	35	40	-	
1573.374~1577.466 MHz		dB	35	40		
1577.466~1585.42 MHz		dB	35	40		
1597.5515~1605.886 MHz		dB	35	40		
1605.886~1680 MHz		dB	35	39		
1710~1785 MHz		dB	33	38		
1805~1880 MHz		dB	33	38		
1710~1755 MHz		dB	33	38		
1900~1920 MHz		dB	32	37		

2010~2025 MHz	dB	32	37		
2110~2170 MHz	dB	32	36		
2402~2470 MHz	dB(*2)	40	47		
2440~2460 MHz	dB(*2)	40	44		
2474 MHz	dB	28	43		
2402~2467 MHz	dB(*3)	35	45		
2474~2500 MHz	dB	1	2.3		
2620~2690 MHz	dB	45	52		
4900~5950 MHz	dB	35	50		
5000~5140 MHz	dB	40	51		
5100~5280 MHz	dB	40	52		
7500~7710 MHz	dB	27	44		
2401~2423 MHz	dB(*2)	45	51		
2406~2428 MHz	dB(*2)	48	53		
2411~2433 MHz	dB(*2)	47	53		
2416~2438 MHz	dB(*2)	45	51		
2421~2443 MHz	dB(*2)	41	49		
2426~2448 MHz	dB(*2)	41	47		
2431~2453 MHz	dB(*2)	40	46		
2436~2458 MHz	dB(*2)	40	45		
2441~2463 MHz	dB(*2)	40	44		
2446~2468 MHz	dB(*2)	40	44		
2451~2473 MHz	dB(*2)	40	45		
2456~2478 MHz	dB(*2)	33	46		
2461~2483 MHz	dB(*2)	23	40		



CAUTION: Electrostatic Sensitive Device. Observe precautions for handling.

NOTES:

1. The design, manufacturing process, and specifications of this device are subject to change.
2. US or International patents may apply.
3. RoHS compliant from the first date of manufacture.

ANT to Rx (f_{T0}=2655 MHz)

Parameters Description		Unit	Min	Typ	Max	Remarks	
Insertion Loss		2620~2690 MHz	dB(*1)	-	2.2	2.6	
VSWR	ANT	2620~2690 MHz	-	1.7	2.3		
	Rx		-	1.8	2.3		
Attenuation:							
1~2500 MHz			dB	40	43	-	
45 MHz			dB	60	99	-	
718~748 MHz			dB	51	58		
814~849 MHz			dB	50	56		
832~862 MHz			dB	50	56		
880~915 MHz			dB	50	55		
1710~1785 MHz			dB	40	45		
1920~1980 MHz			dB	40	44		
2400~2500 MHz			dB	40	48		
2402~2470 MHz			dB	44	48		
2500~2570 MHz			dB	45	57		
2570~2600 MHz			dB	1	8		
2775~2790 MHz			dB	37	64		
2775~6000 MHz			dB	40	47		
4900~5300 MHz			dB	47	59		
5300~5950 MHz			dB	40	58		
7620~7830 MHz			dB	40	48		
7860~8070 MHz			dB	40	47		

Tx to Rx

Isolation	2500~2570 MHz	dB	55	58	-	
	2620~2690 MHz	dB	52	57	-	
	1574~1577 MHz	dB	50	70		
	5000~5140 MHz	dB	32	57		
	7500~7710MHz	dB	25	48		

(*1) Specification of insertion loss excludes loss that comes from the test board.

(*2) Integrated attenuation per 22MHz

(*3) Integrated attenuation per 18MHz

FREQUENCY CHARACTERISTICS:

Tx to Ant

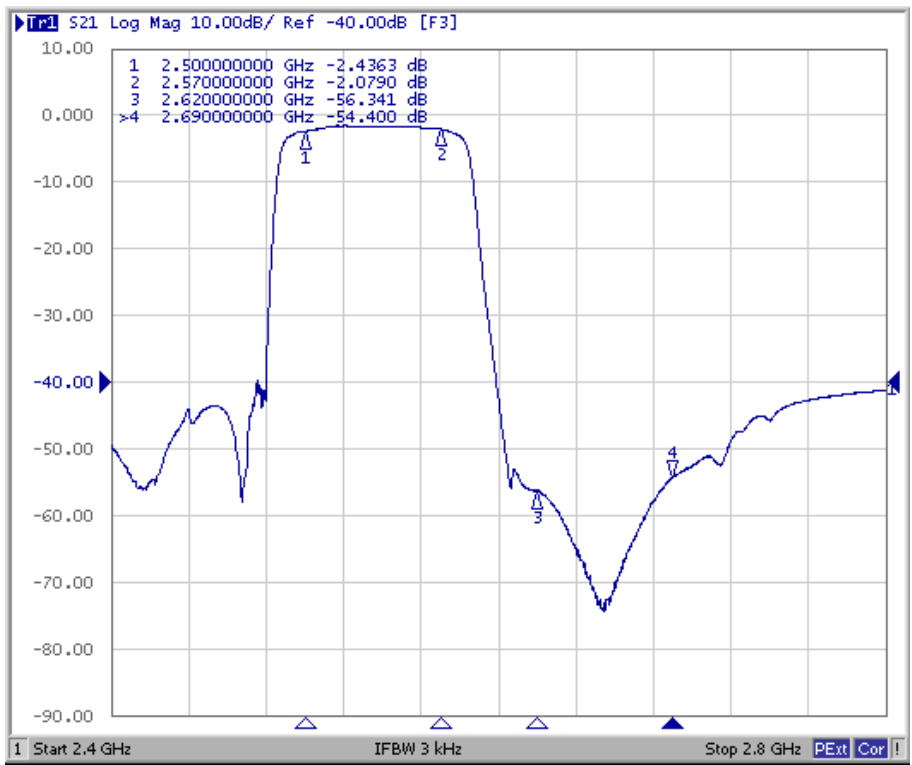

Ant to Rx

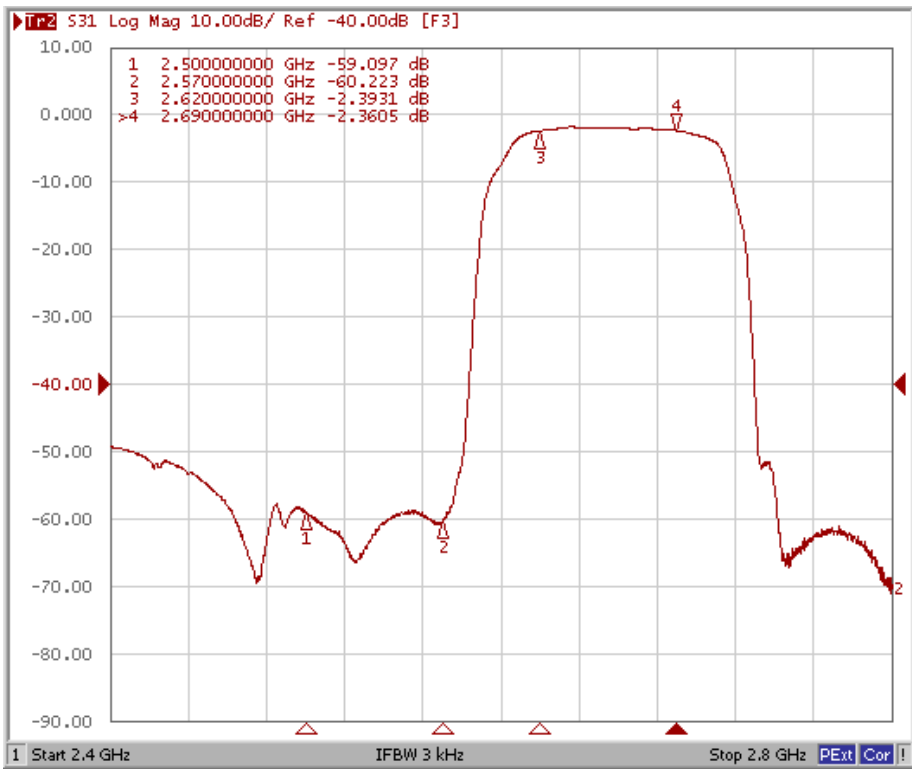

Tx to Ant ,Ant to Rx

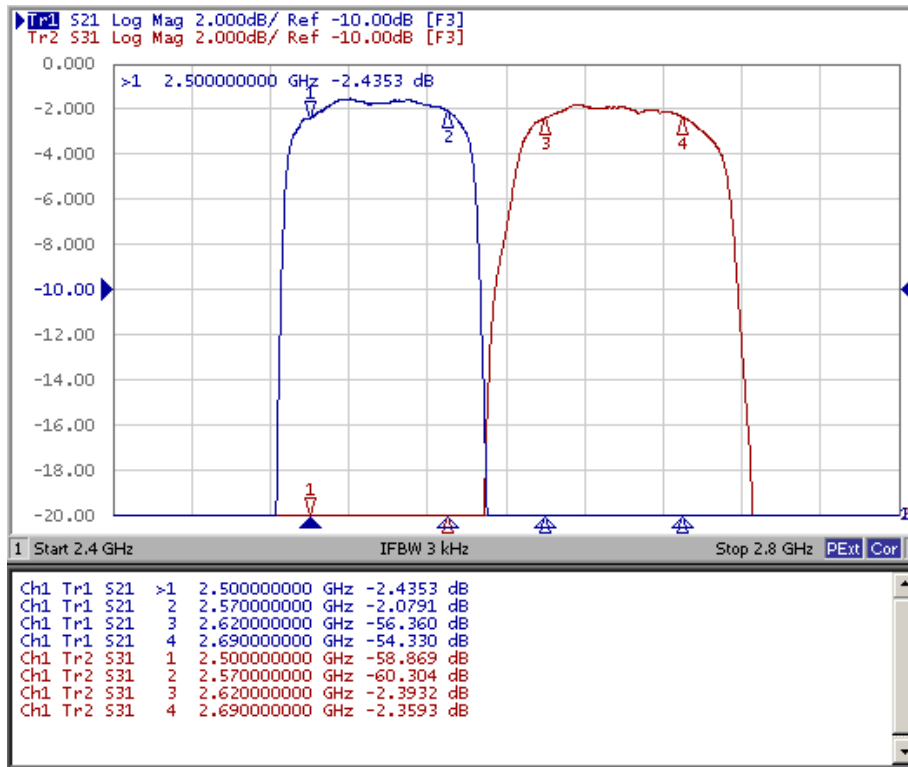

Tx to Rx Isolation

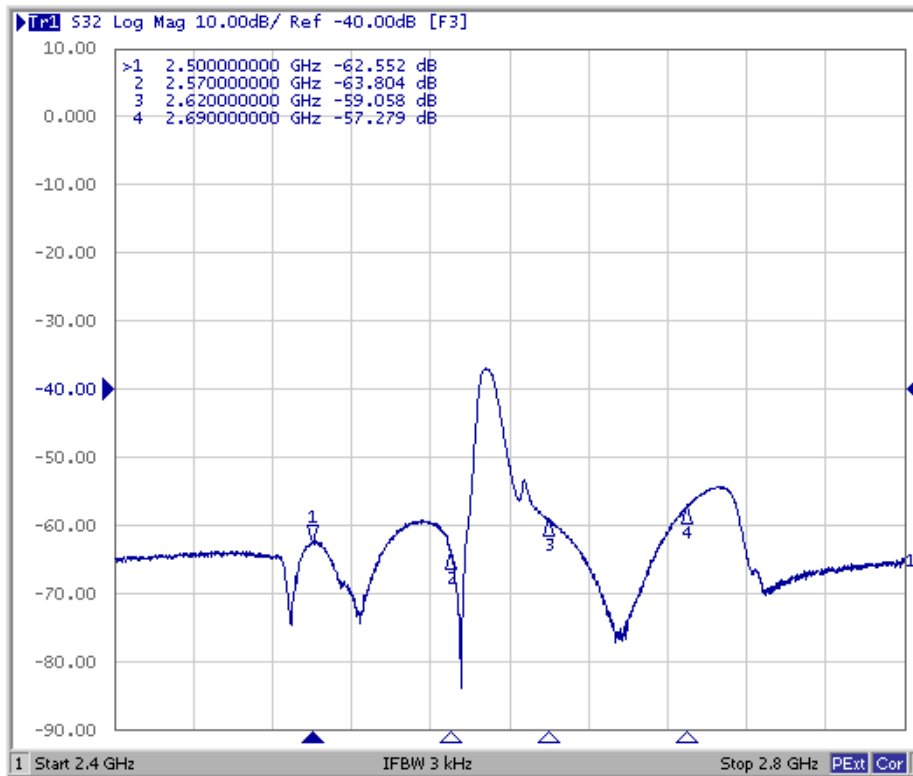

These data **exclude** loss that comes from the test board

Tx Port

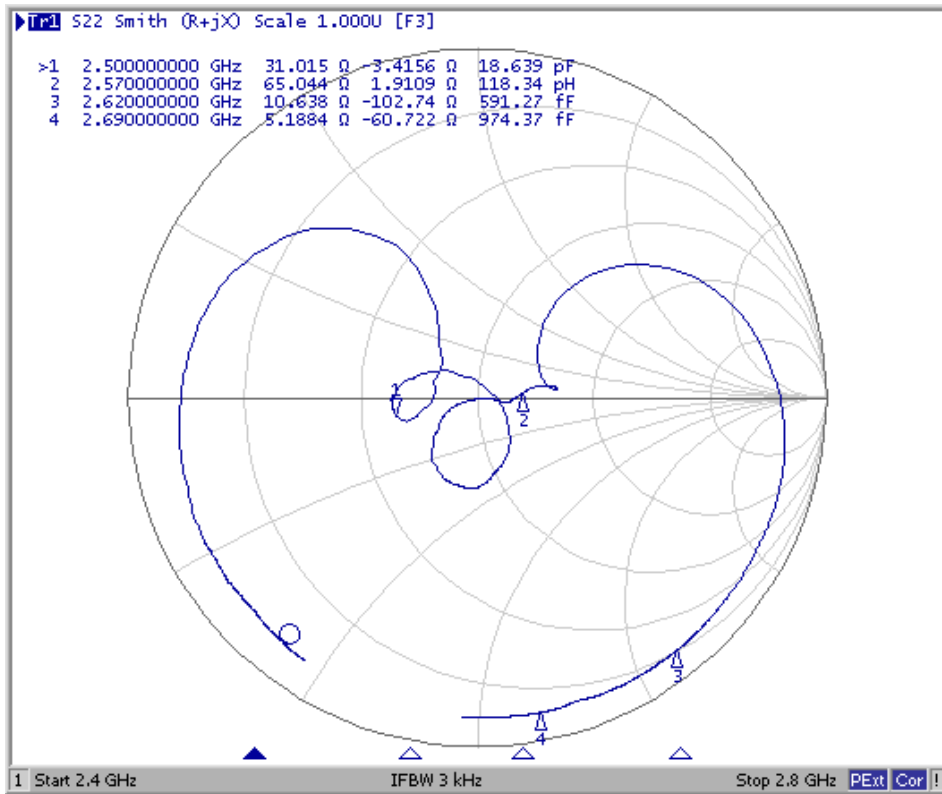
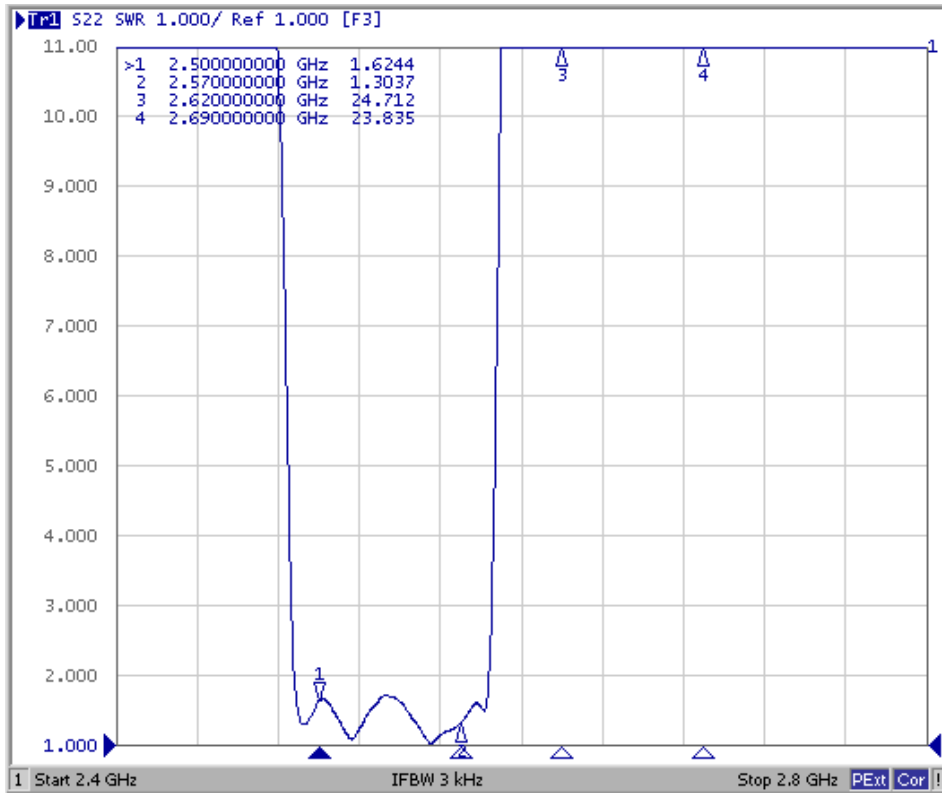

Rx Port

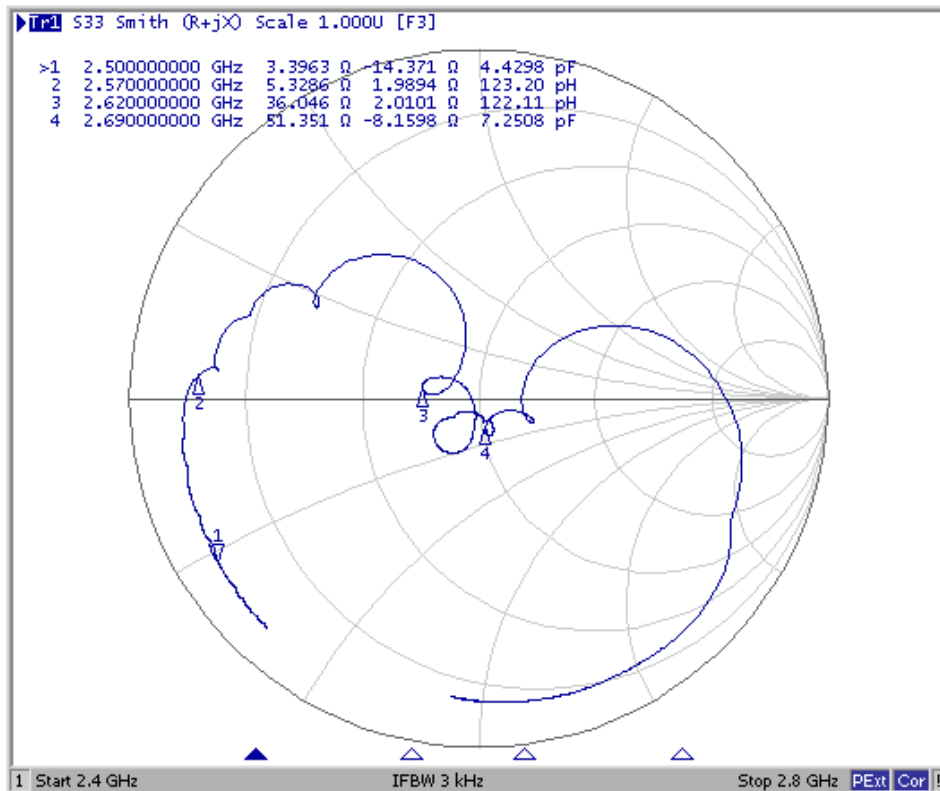
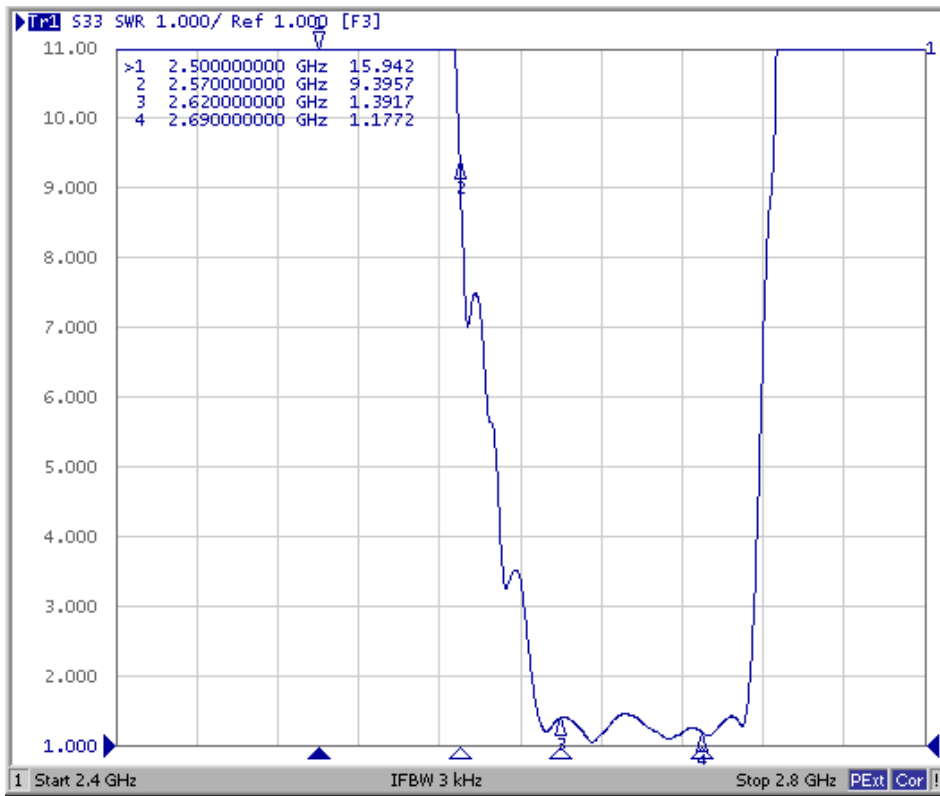

Ant Port

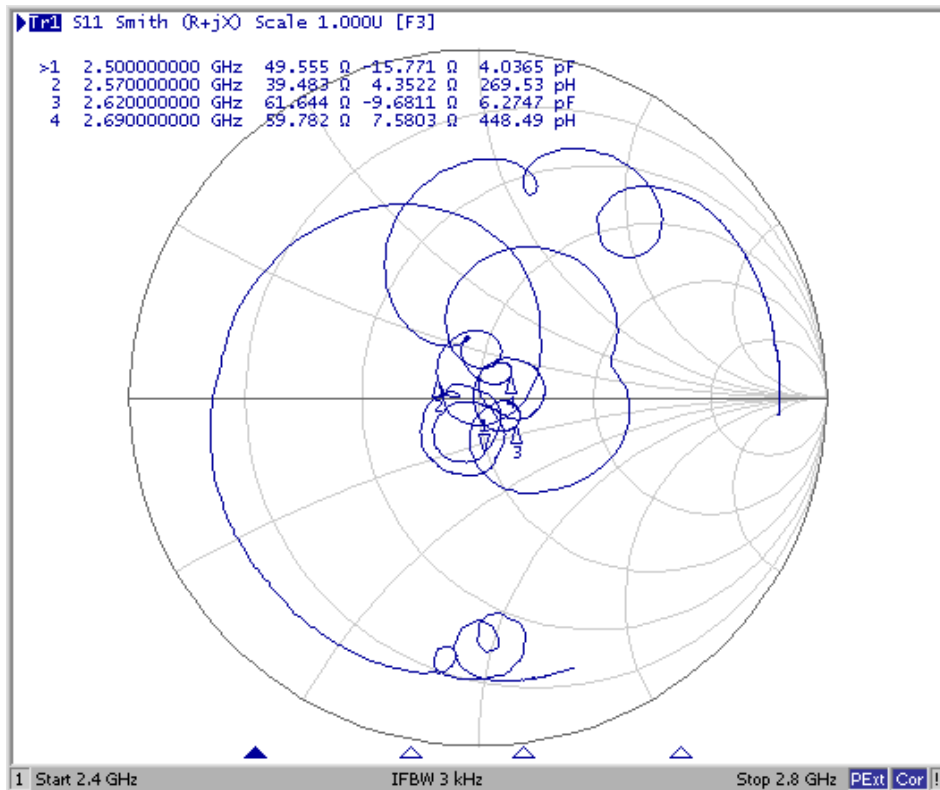
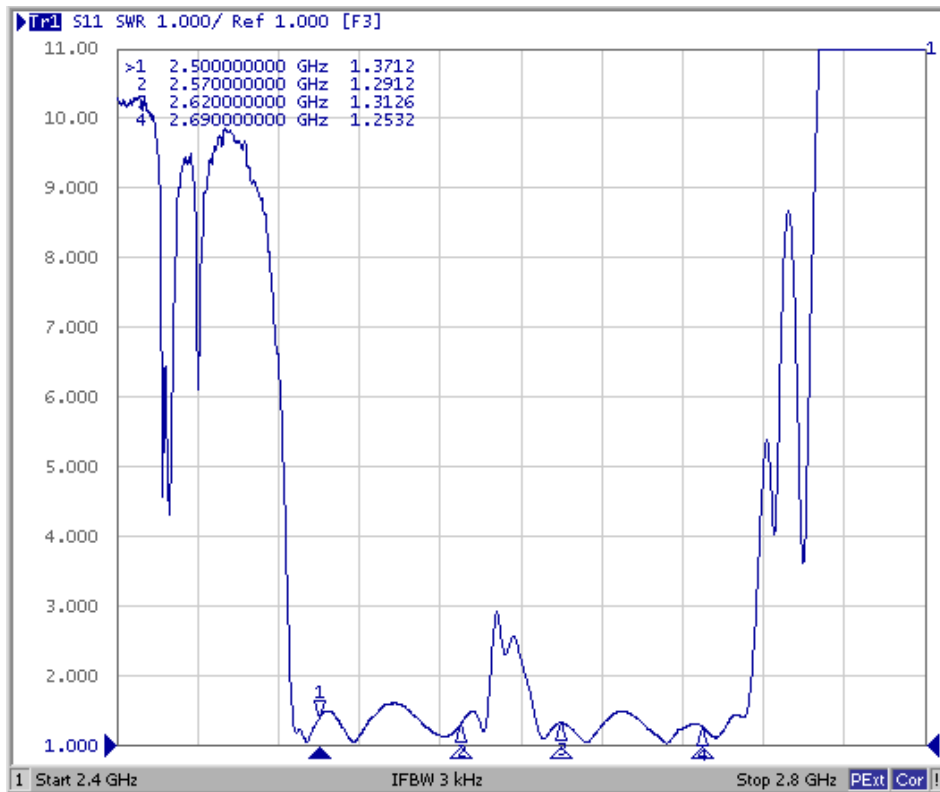

Tx to Ant (Wide span)

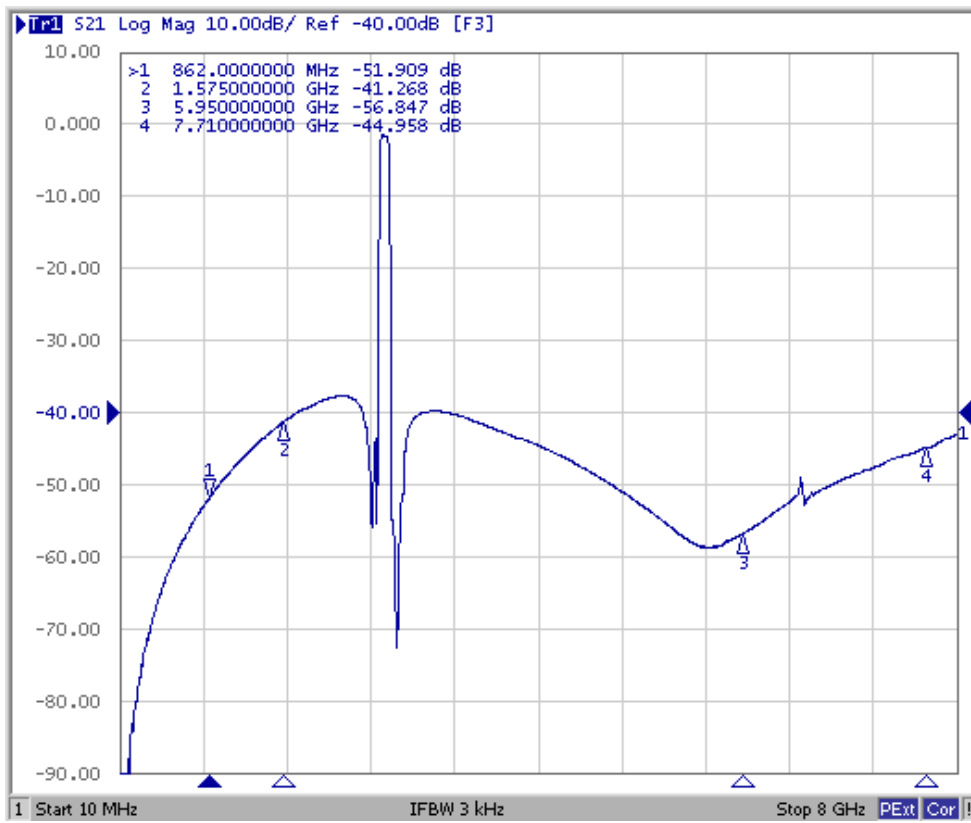

Ant to Rx (Wide span)

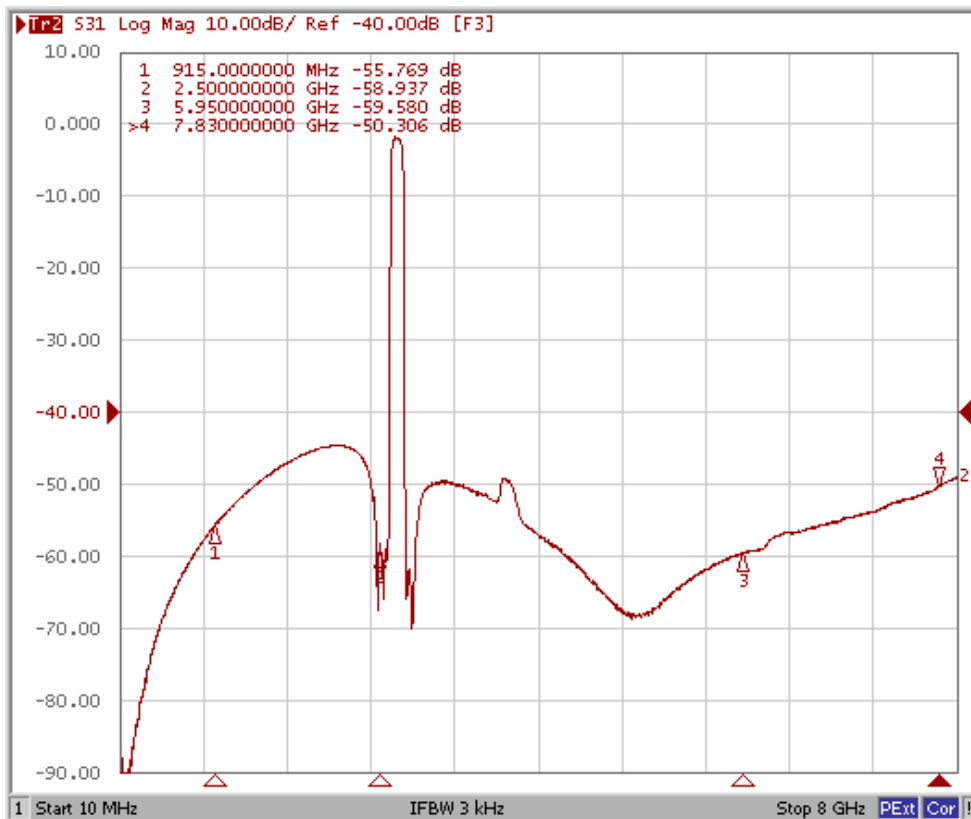

Tx to Rx Isolation (Wide span)

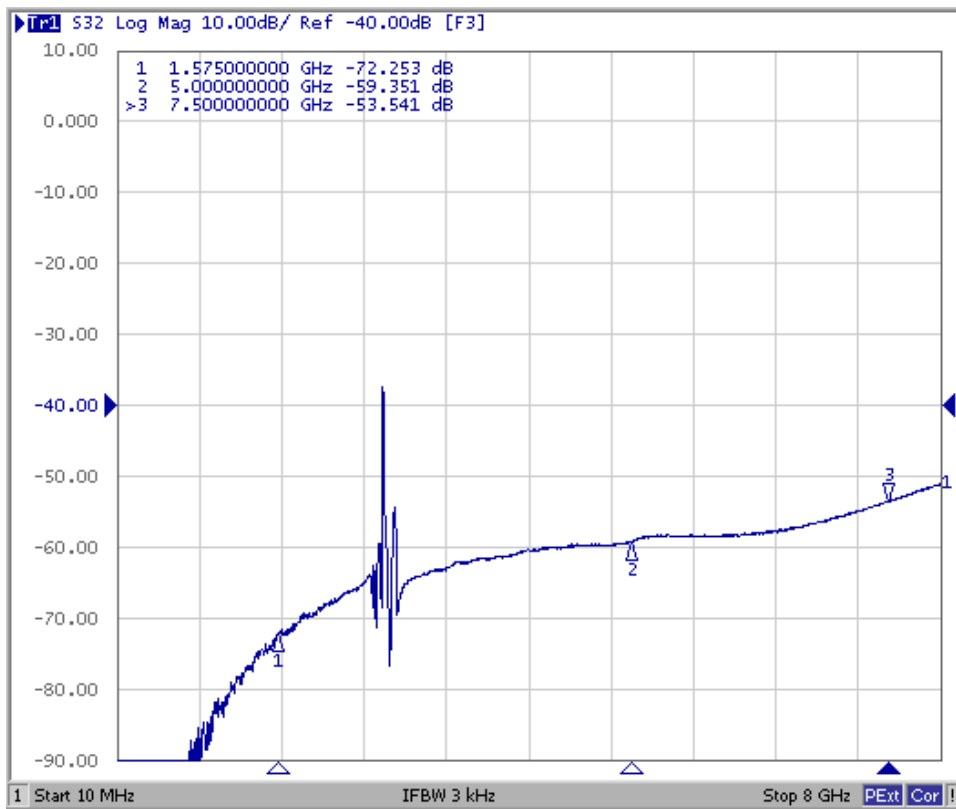

OUTLINE DRAWING:

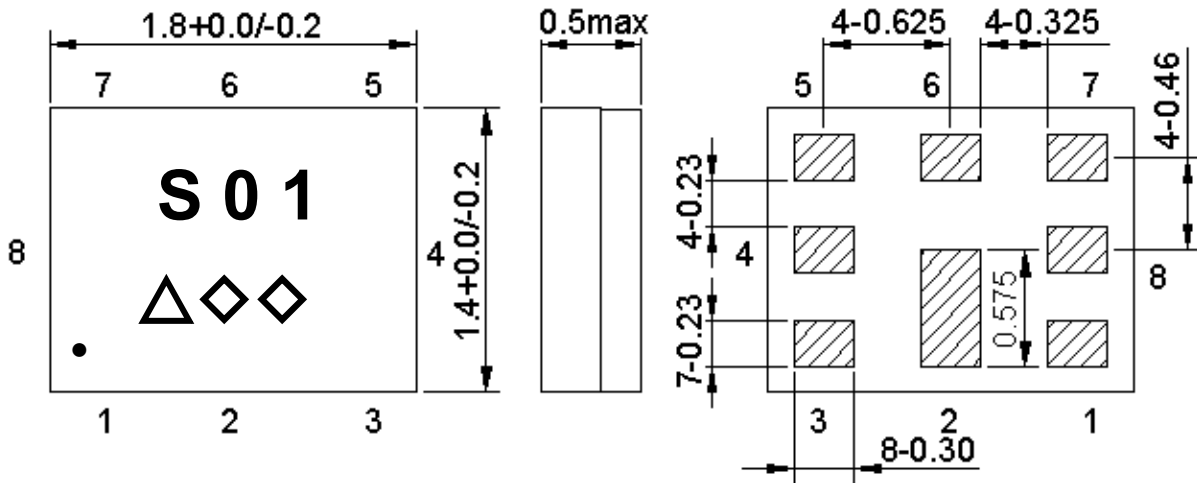

Not Specified Tolerance : ± 0.05 mm

Coplanarity : 0.1 mm max.

1 to 8 : Pin No.

Unit : mm

Marking name : **S01**

Δ : Date code(2016 May \rightarrow s ,....., 2019 Dec \rightarrow m.)

$\diamond\diamond$: Lot Code.

Product Date Code. Follow below table.

Year	Jan	Feb	Mar	Apr	May	Jun	Jul	Aug	Sep	Oct	Nov	Dec
2016	n	p	q	r	s	t	u	v	w	x	y	z
2017	A	B	C	D	E	F	G	H	J	K	L	M
2018	N	P	Q	R	S	T	U	V	W	X	Y	Z
2019	a	b	c	d	e	f	g	h	j	k	l	m

Pin Configuration:

Pin No.	Pin Name	Description
1	Rx	Receive Pin
2	GND	Ground Pin
3	Tx	Transmitter Pin
4	GND	Ground Pin
5	GND	Ground Pin
6	ANT	Antenna Pin
7	GND	Ground Pin
8	GND	Ground Pin

Evaluation Circuit

Evaluation Circuit

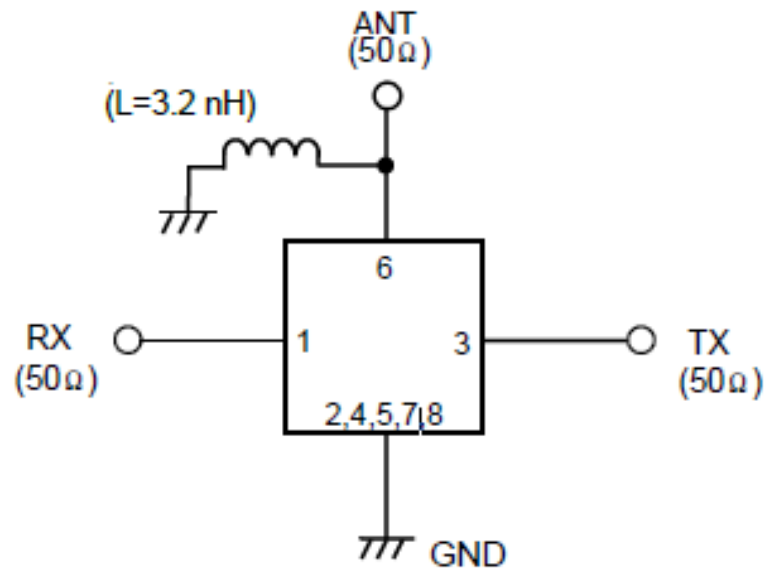

FOOTPRINT:

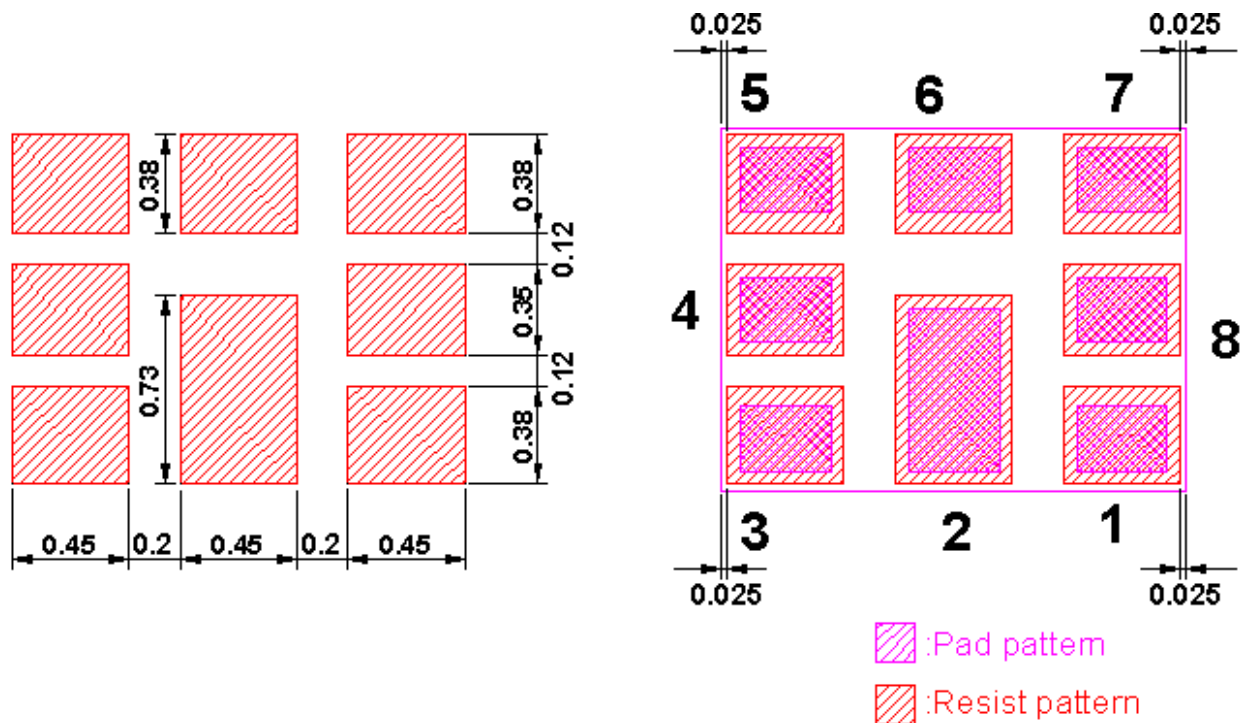

Reel Count"

7" = 3000

13" = 10,000

PACKING:

REEL DIMENSION

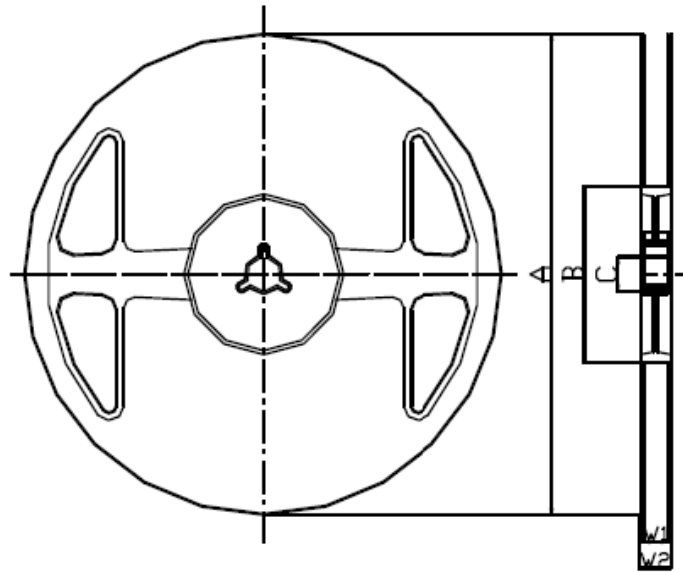

Materials of Reel

Material : Polystyrene + Carbon

Characteristics : Conforms to EIAJ-ET-7200A

Color : Black

Surface resistance (reference value) : $10^9\Omega/\text{sq}$ Max.

Unit : mm

Code	Quantity	A	B	C	W1	W2
Z	3,000 pcs	$\phi 180.0 +0.0/-1.5$	$\phi 66.0 +/-0.5$	$\phi 13.0 +/-0.2$	$9.0 +1.0/-0.0$	$11.4 +/-1.0$

TAPE DIMENSION

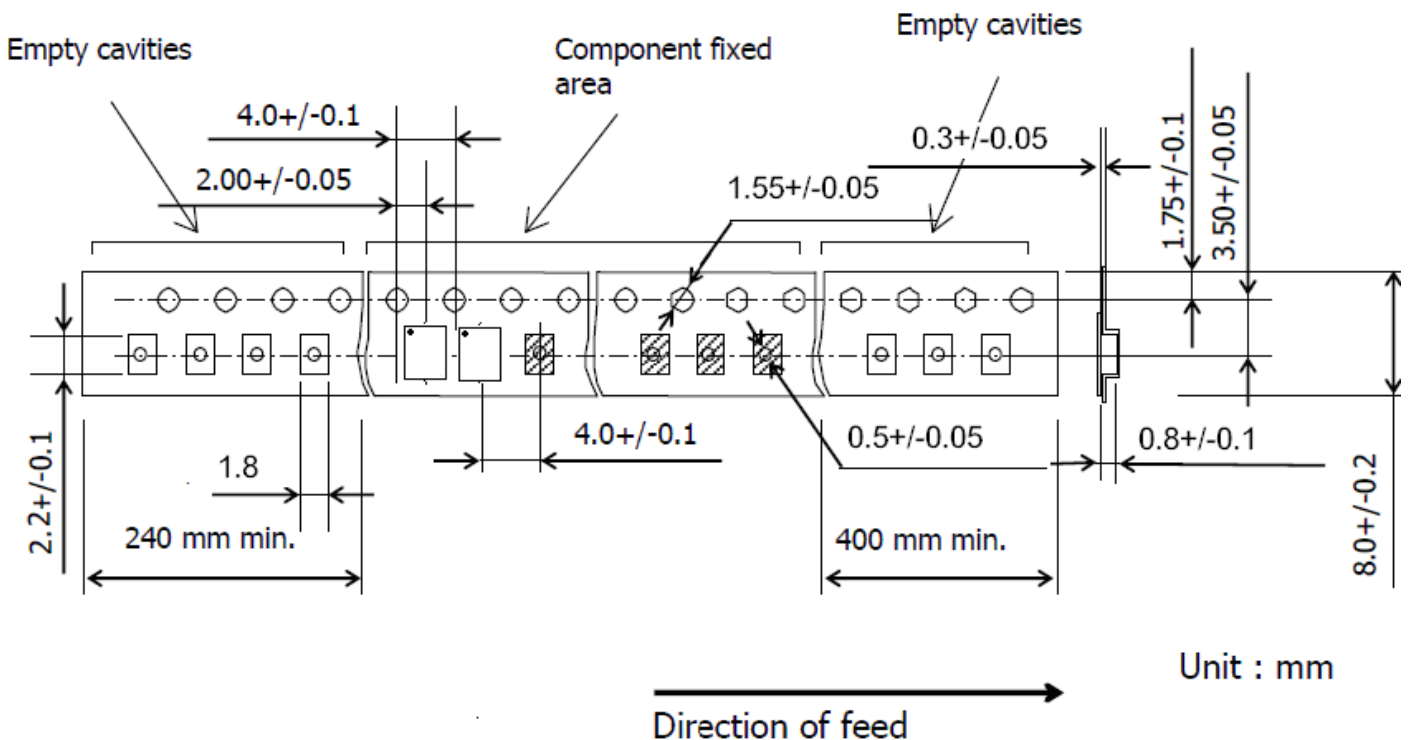

Unit : mm

RECOMMENDED REFLOW PROFILE :

1. Preheating shall be fixed at 150~180°C for 60~90 seconds.
2. Ascending time to preheating temperature 150°C shall be 30 seconds min.
3. Heating shall be fixed at 220°C for 50~80 seconds and at 245~260°C peak (min. 10sec).
4. Time : 2 times.

